

CARGO PUMPING SYSTEM



FRAMO CARGO PUMPING SYSTEM

Framo hydraulically driven submerged cargo pumps provide safe, efficient and flexible cargo handling of any type of liquid cargo. Improved cargo handling performance gives quicker turnaround time, more ton-miles and fewer voyages in ballast.

HIGH VESSEL UTILISATION
CLEAN SEAS

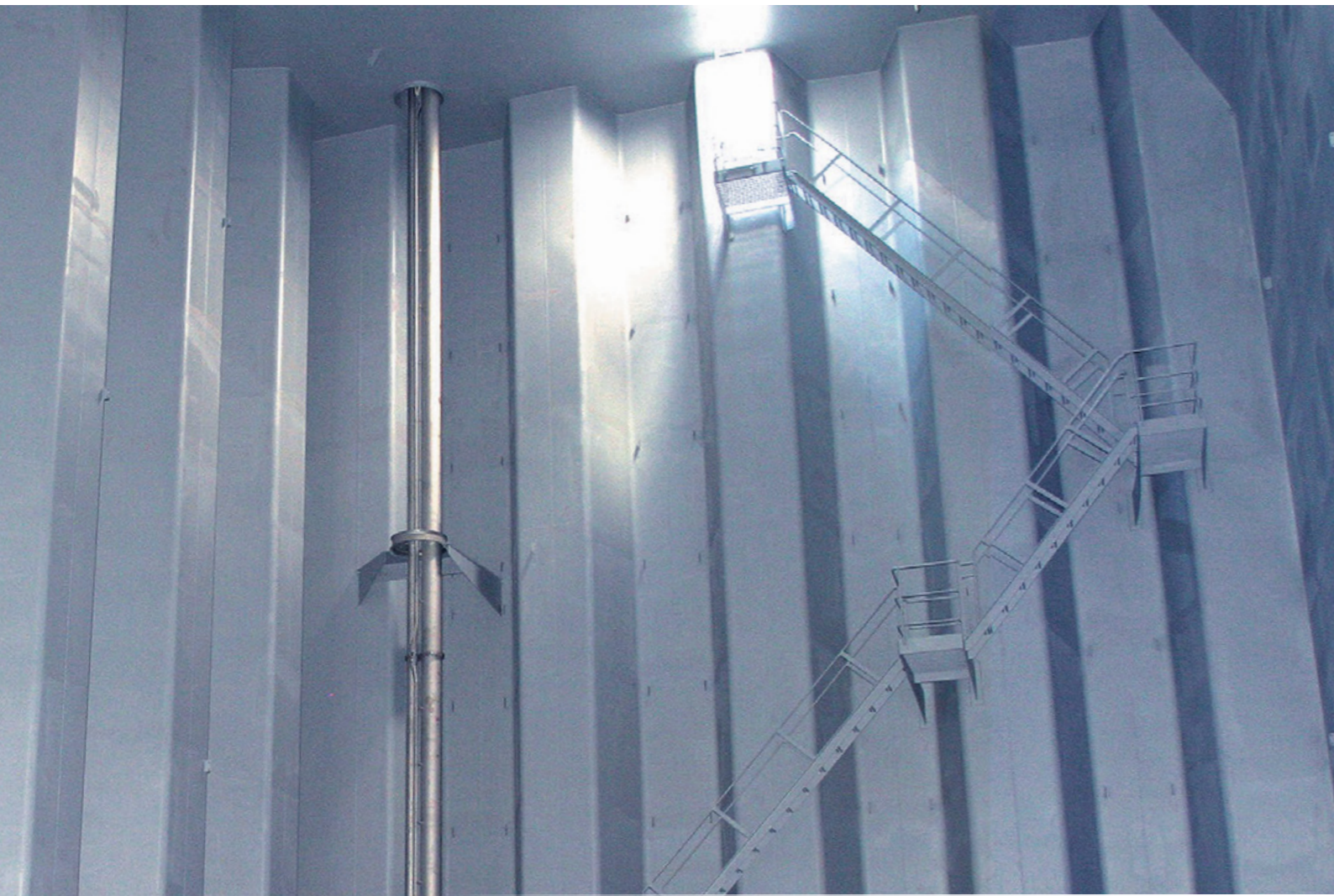

Made to perform
The Framo cargo pump is of a robust construction made to efficiently empty any cargo tank containing the most heavy, viscous or aggressive cargoes.
The hydraulic driveline is designed for a safe and reliable pumping and final stripping of the most volatile or dangerous cargoes carried in bulk.
No risks of any build up of heat due to a fail-safe design where the pump motor and bearings are constantly lubricated and cooled by the hydraulic oil driving medium.



M/T "STOLT NORLAND" 43,000 tdw chemical tanker. Owner Stolt-Nielsen, Netherlands. Built STX Norway Florø, 2009.

- SAVE TIME**
- Spend less time on cargo operations
 - Quick cargo unloading
 - Efficient stripping
 - Less slop treatment

Load any type of cargo
The Framo cargo pump can handle any type of cargo. One voyage it may be a petroleum product, next voyage an acid or something heated/cooled/volatile or viscous.
Efficient switch between different cargoes
A cargo pumping system must be able to discharge, drain and clean the cargo tanks in an efficient manner to make the vessel ready to receive a new cargo.



CONTENTS	
Framo cargo pumping system	2
The submerged cargo pump	6
Safe operation	8
Cargo heating	10
Submerged ballast pumps	12
Submerged tank cleaning pumps	13
Hydraulic drive	14
Framo piping	16
Cargo piping	18
Cargo cooling	20
Cargo circulation	21
Floating production, storage and offloading	22
Technical data	24
Research and development	26
Customer support	28
Framo AS	30

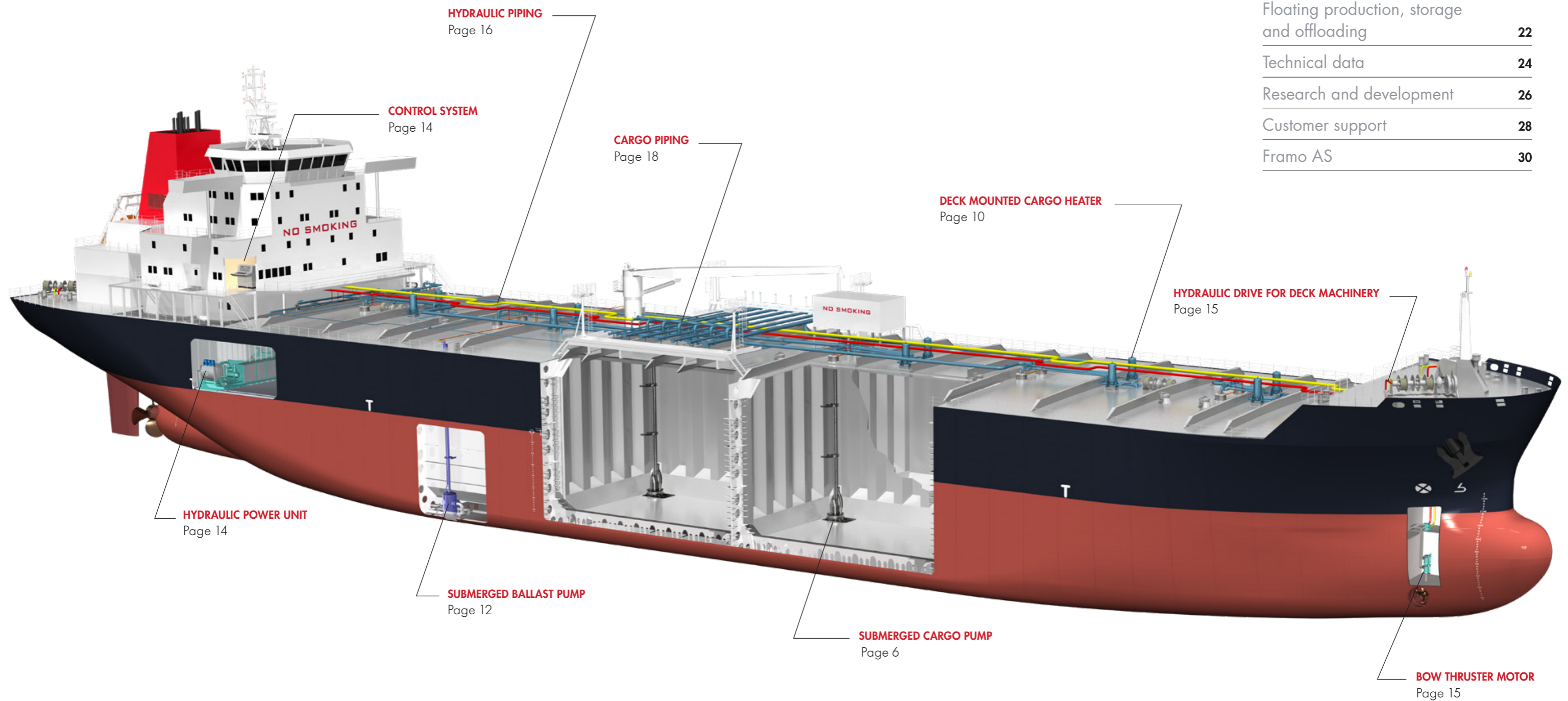

THE SUBMERGED CARGO PUMP

The Framo cargo pump is a vertical single stage centrifugal pump powered by a hydraulic motor for safe and efficient operation. All our cargo pumps are made in stainless steel material and designed with a smooth and easy-to-clean surface with a limited number of flanges which gives a superior ability to pump any liquid.

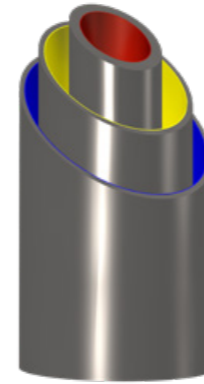

The hydraulic high pressure pipe is located inside the low pressure return oil pipe. The entire hydraulic section is separated from the cargo by a cofferdam ventilated to atmosphere.

The cargo pump has a built-in hydraulic motor connected to the impeller by a short independent shaft. Motor, shaft and bearings are lubricated and cooled by the hydraulic driving oil.

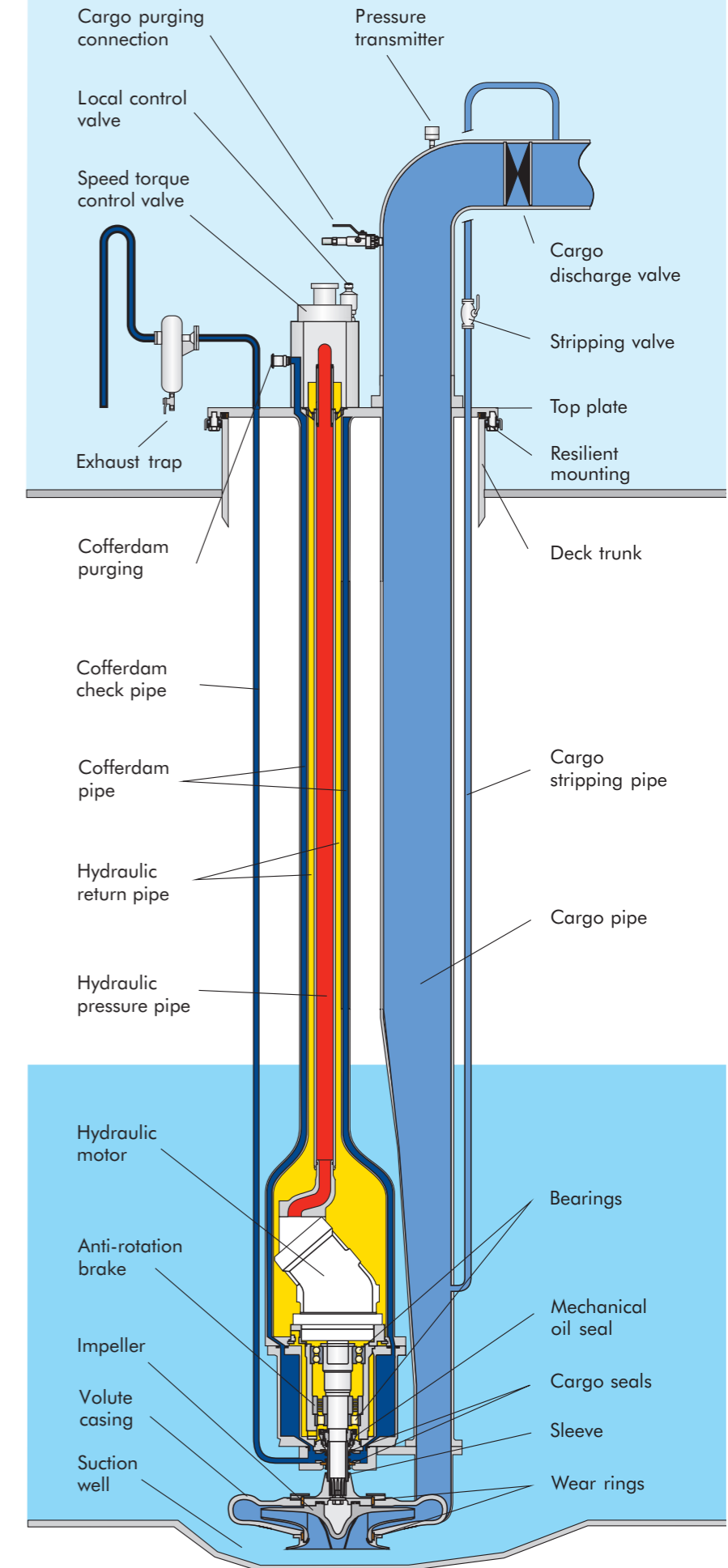

Design features

- Vertical single stage, single suction impeller, axially balanced
- Robust hydraulic drive with short and stiff drive shaft
- Fail-safe design; lubrication and cooling of pump by the hydraulic driving oil medium
- Pump material stainless steel
- Concentric hydraulic pipes for maximum safety
- Cofferdam, ventilated to atmosphere, protecting the entire pump
- Mechanical seal against hydraulic oil
- Double lip seal against cargo, only exposed to static pressure
- Anti-rotation brake; loading through pump
- Smooth pump exterior; self draining and easy to clean

Performance

The Framo cargo pump is easy to operate. The hydraulic drive provides for a remote and local stepless capacity control through the Speed Torque Control (STC) valve on the pump's top plate. The cargo pump can pump anything liquid, regardless of specific weight or viscosity.

It is impossible to overload or to over-speed the pump. The STC valve automatically regulates hydraulic oil pressure and flow to the hydraulic motor according to the given discharge situation.

The pump design allows operation with a minimum of liquid in the tank which saves time spent for drainage and tank cleaning. The Framo cargo pump has a built-in efficient stripping system.

Condition based maintenance

Seal monitoring is performed from the cargo pump top plate by purging the cofferdam.

Replacement of wear and tear parts is easily done from inside of the tank without interfering with the hydraulic section.

SAFE OPERATION

Dangerous chemicals, acids, oils or edibles must be handled in a safe way for people and environment. The tanker must be equipped with cargo pumps that can efficiently empty cargo tanks and associated cargo piping to meet the most stringent requirements, and withstand the tough impact during hours of tank cleaning afterwards. Switch between cargoes without cargo contamination. Carry anything from acids to drinking water.

STAINLESS STEEL CHEMICAL TANKERS

The stainless steel chemical tanker fleet comprises the most sophisticated tankers sailing on the high seas. These ships are constructed with stainless steel cargo tanks, a fully segregated cargo pumping arrangement and designed to carry the most aggressive, corrosive or volatile liquids.



M/T "BOW SIRIUS" 40.000 tdw chemical tanker.
Owner Odjell, Norway.
Built Szczecin Shipyard, Poland 2006.

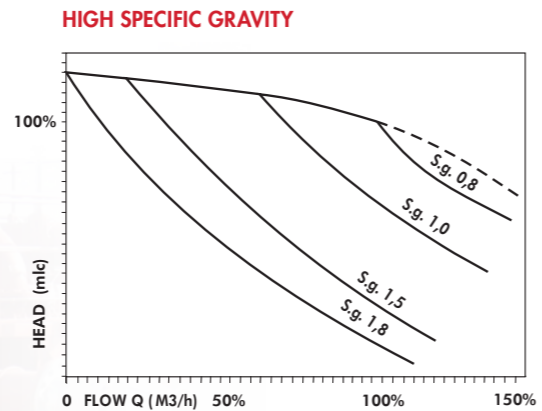

- Hydraulic drive and torque control, no risk of overloading
- Any specific gravity of cargo, no limitation

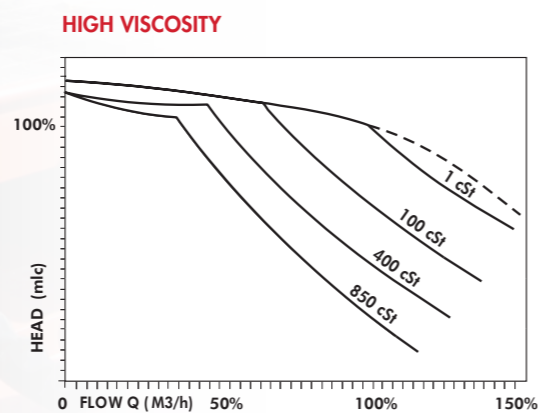

- Full torque at any speed
- Extremely viscous cargoes, molasses etc.

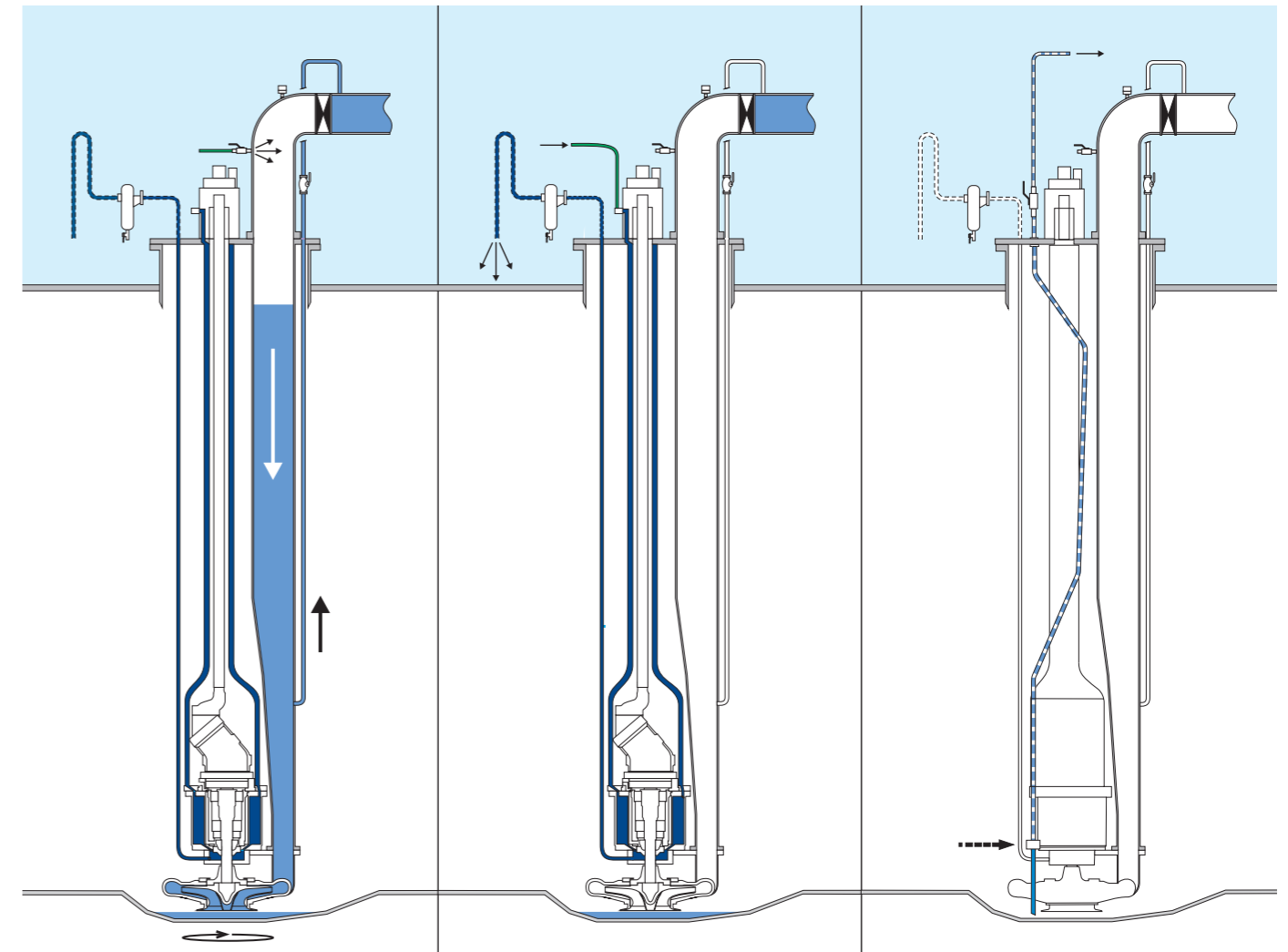

High or low temperature, volatile and dangerous cargoes

The Framo cargo pump is designed for any cargo temperatures prevailing in tankers. The pump is continuously temperature controlled by the circulating hydraulic drive oil.

The Framo cargo seal arrangement is exposed to static cargo tank pressure only.

Optimal operating conditions are maintained at all pumping conditions. Volatile or heat sensitive cargoes can be discharged efficiently in a safe manner.

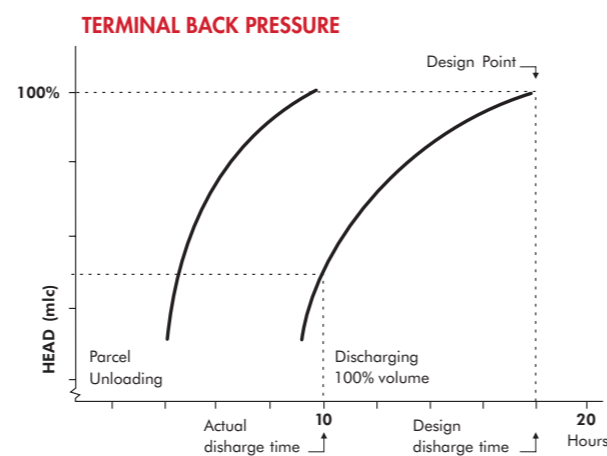

- Increase the discharge rate at lower back pressure
- Shorter discharge time

Stripping

When the cargo tank is empty, the speed of the cargo pump is reduced to perform the final stripping of tank:

- Close the cargo valve
- Open the small ball valve on the stripping line
- Pressurize the pipe stack by connecting the purging hose with compressed air or nitrogen
- Press cargo out through the stripping line and into the cargo line

The pump impeller rotates and acts as a non-return valve to prevent cargo from returning back to tank.

Purging and seal monitoring from deck level

The pump's cofferdam is purged before and after discharge operation. Any leakage across the cargo seals or hydraulic oil seals collected in the cofferdam, will be forced to the exhaust trap on deck where it can be measured.

This is a simple and reliable seal condition monitoring system. No need for any electric sensors nor any automatic control system.

Vacuum drain

The standard Framo cargo pump design meets all applicable rules for stripping under the IMO Annex II requirements.

However, as an option, the Framo cargo pump can be equipped with a vacuum drain line that will empty suction well completely and allow for a dry tank top and quick re-loading of cargo.

CARGO HEATING

Framo deck mounted cargo heaters eliminate the need for in-tank heating coils. The cargo tank interior can be made with flush tank top free from coils, brackets and clamps. A flush tank top facilitates quicker stripping with less cargo remaining in the tank. The cargo tank washing can be performed quicker, with less consumption of washing water and less slop handling.

CHEMICAL/PRODUCT OIL TANKERS

Most of the world's production of vegetable oils, commodity chemicals and refined petroleum products are transported on the large fleet of modern chemical/product tankers. Typically designed with coated cargo tanks, six to eight cargo segregations, no pump room, submerged ballast pumps, in-tank cargo pumps and deck mounted cargo heaters.



M/T "OVERSEAS ATALMAR" 45.900 tdw chemical/product tanker. Owner OSG, USA. Built STX Shipbuilding, Korea 2004.

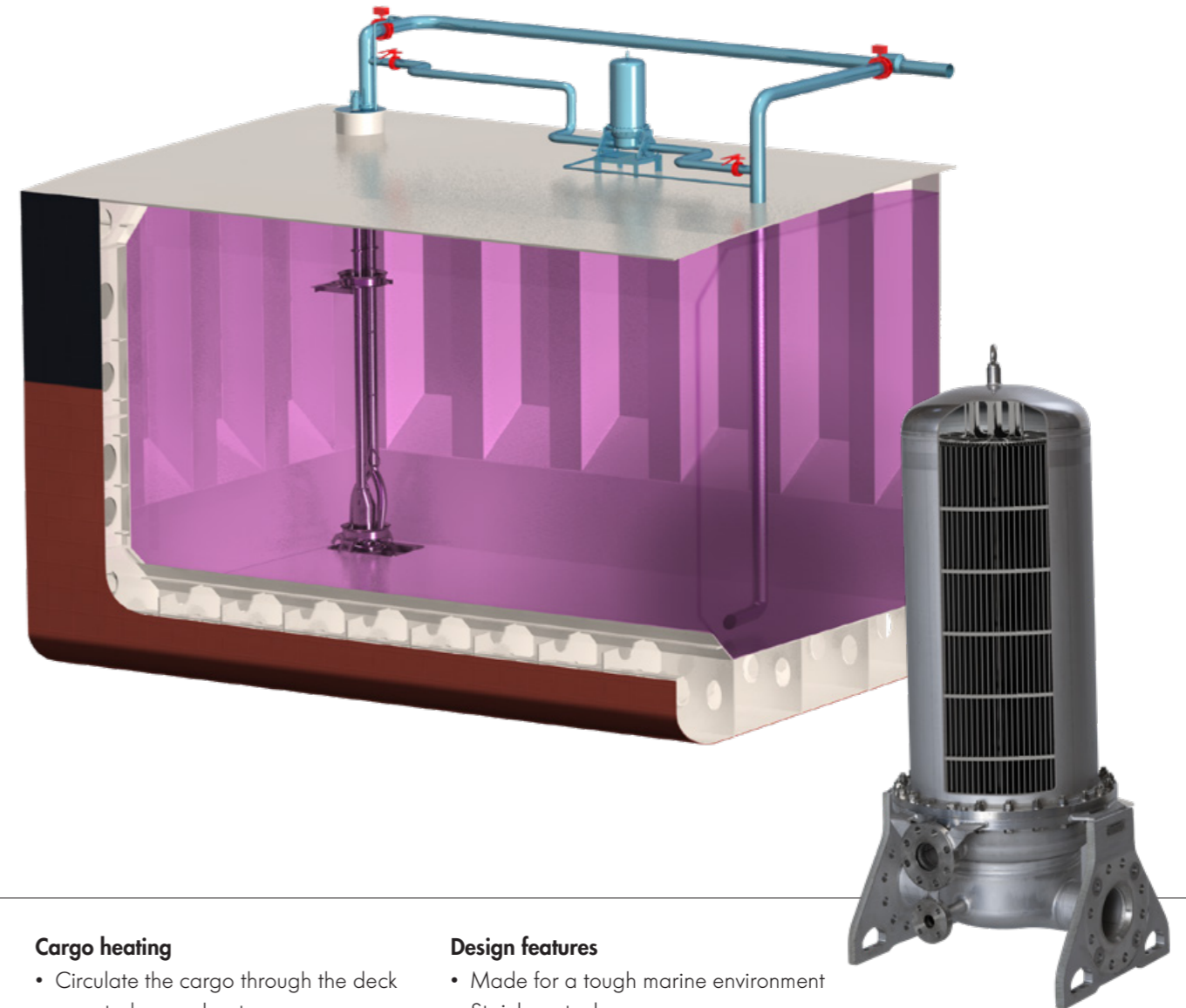
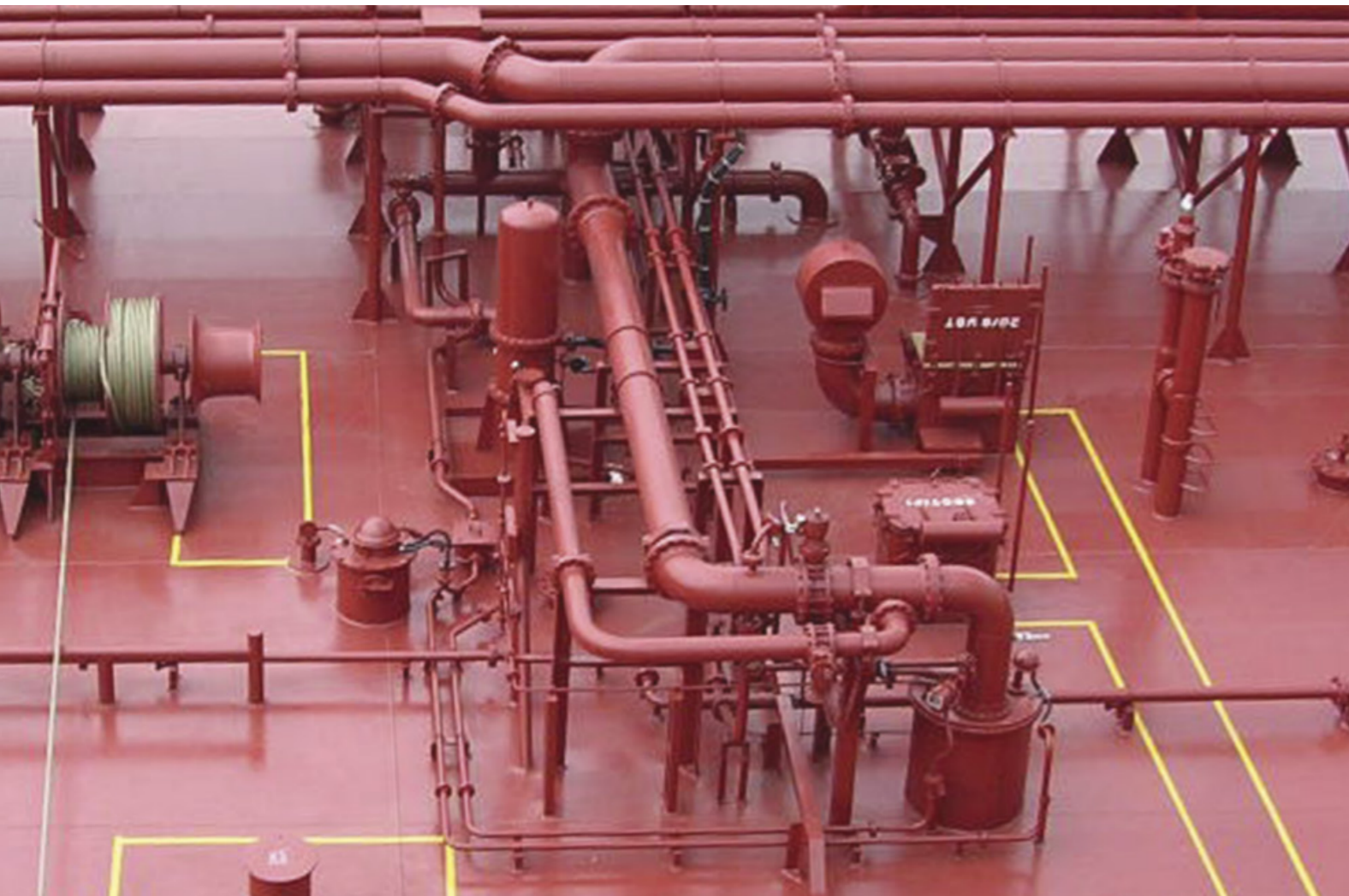

Performance

High flexibility to heat all traded cargoes, such as heavy fuel oils, oil products, palm oils and other chemicals that may be temperature sensitive and requires a gentle heating procedure.

The specially shaped heating elements secure easy cargo circulation and have a low surface temperature against cargo.

The high capacity and low pressure drop through the cargo heater gives a low power

consumption during circulation and secure a good mixing and heat distribution inside the cargo tank.

The heating medium can be saturated steam, hot water or thermal oil.

Framo deck mounted cargo heating system is supplied as an integral part of the cargo pumping system for all sizes of oil tankers, chemical tankers and FPSOs.

Cargo heating

- Circulate the cargo through the deck mounted cargo heater
- Adjust heating capacity to meet cargo requirements
- Heat gently with careful temperature increase across the heater
- High circulated cargo flow gives a good heat distribution inside the cargo tank

Design features

- Made for a tough marine environment
- Stainless steel
- Compact welded plate type design
- Large heating surface
- Low pressure drop
- Vertical self draining
- Easy to clean
- Easy to inspect
- Cargo heater is only exposed to cargo when in use

SUBMERGED BALLAST PUMPS

Installation of ballast pumps inside the double side ballast tanks in combination with a submerged cargo pump in each cargo tank make the pump room superfluous. This arrangement provides a safer ship design and make more space available for carrying cargo. Submerged ballast pumps have become the standard arrangement in modern tankers and FPSOs.

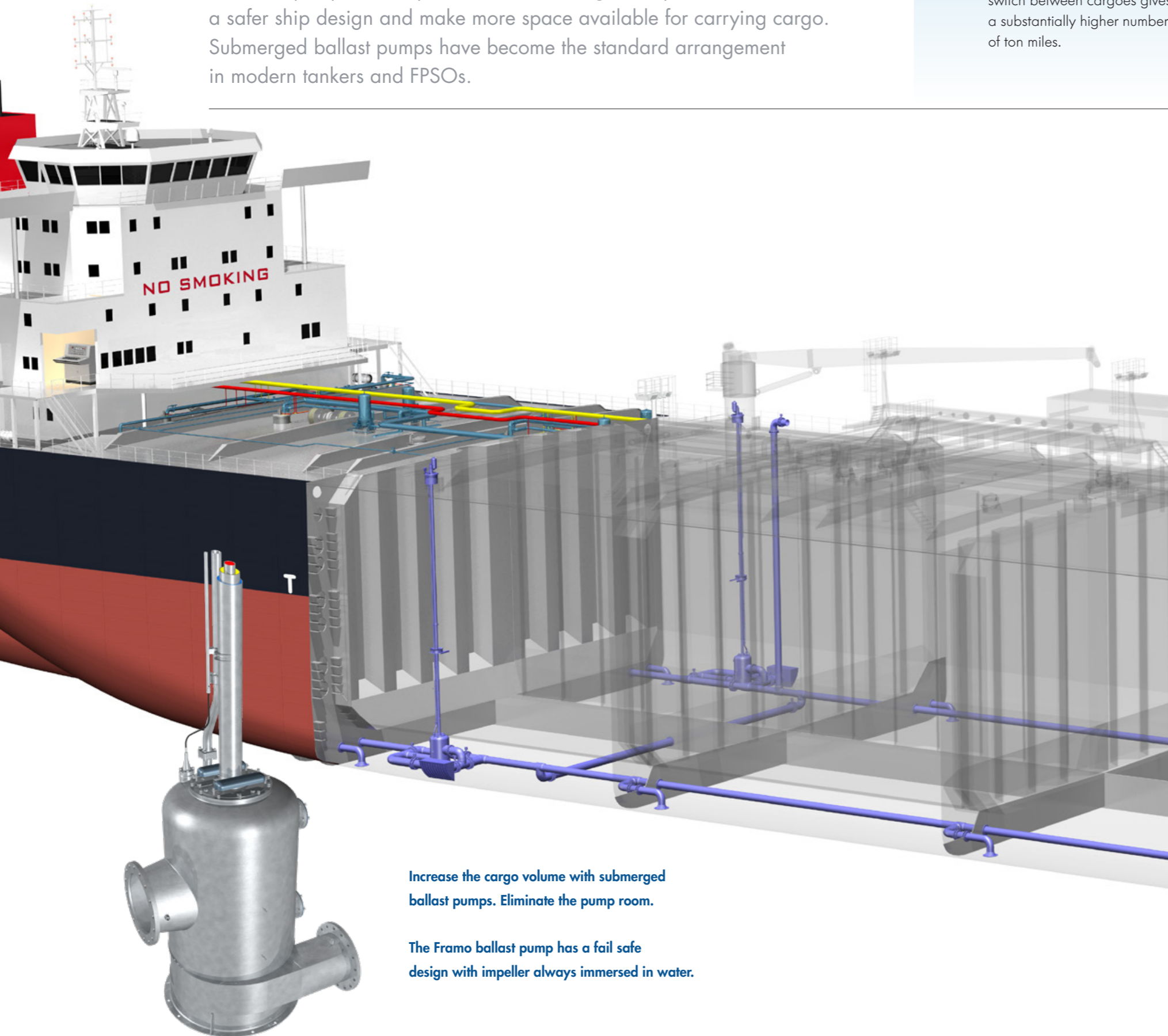

Increase the cargo volume with submerged ballast pumps. Eliminate the pump room.

The Framo ballast pump has a fail safe design with impeller always immersed in water.

LONG RANGE TANKERS

The use of one submerged hydraulically driven cargo pump per tank provides safe segregation between cargoes. It makes the stripping and tank cleaning quicker. Efficient switch between cargoes gives a substantially higher number of ton miles.



M/T "SKS DOURO" 120.000 tdw product tanker.
Owner Kristian Gerhard Jebsen, Norway.
Built Hyundai Samho Heavy Industries, Korea 2010.

Increased cargo volume

Normally installed inside two of the double side ballast tanks located aft of the manifold area, one in each side. On oil tankers, a fuel-oil tank can separate the engine room and cargo section.

- No pump room required
- Larger volume available for cargo

Submerged installation

The Framo submerged ballast pump is a centrifugal pump, designed for installation inside the ballast tanks.

The pump unit is mounted inside the air separator and protected by a cofferdam. A fail-safe design ensures that impeller will always be immersed in water.

This is a compact design which saves space and makes the installation easy. An air ejector is connected to the pumps suction side. Automatic start and stop of the air ejector makes the pump self priming.

The pump is manufactured from stainless steel with seawater resistant bronze impeller.

Design features

- Impeller always immersed in water
- Built-in self priming system
- Individual capacities of up to 3.000 m³/h
- Stepless capacity control
- Robust design with a short and rigid drive shaft
- Lubrication and cooling of motor and bearings by the hydraulic drive oil
- Cofferdam between ballast water and hydraulic section
- Concentric hydraulic pipes for maximum safety
- Easy to install, operate and maintain
- Can be connected to any ballast water treatment system

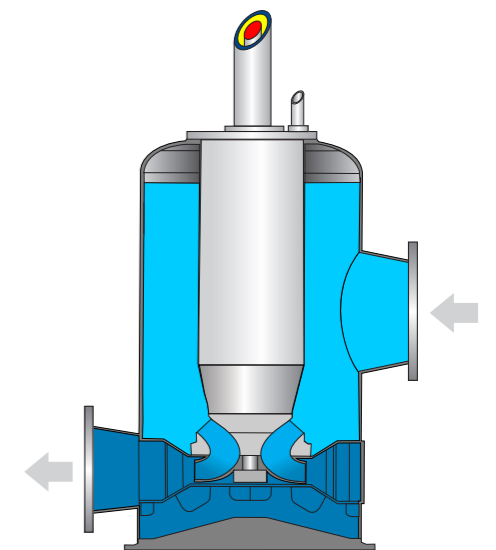

SUBMERGED TANK CLEANING PUMPS

The Framo submerged tank cleaning pump is based on the submerged cargo pump design and equipped with a suction arrangement to allow for suction from sea chest and technical fresh water tank.

Framo also supply a range of tank cleaning pumps for dry installation. Any Framo pump with hydraulic drive is 100% explosion proof, and can be installed in hazardous areas.

HYDRAULIC DRIVE

A complete system designed and manufactured by Framo. Hydraulic drive provides the most flexible and safe power transmission for a cargo pumping system on tankers.

Hydraulic power unit

The hydraulic power pack prime movers can be electric motors or diesel engines.

A combination of electric motor and diesel engine prime movers allows the ship's generators to be designed for the relatively low power requirement in sea-going mode rather than the considerably higher requirement during cargo unloading. The ship's auxiliary engines can therefore operate with an economic load while at sea where the majority of running hours will be. The diesel hydraulic power packs will provide any additional power needed for a high capacity/high head cargo discharge.

All power packs, stainless steel system tank, oil cooler, and full flow filter are mounted, piped and wired on a module for resilient installation onboard.

This Hydraulic power unit is full scale tested together with the control system module before shipment.

The hydraulic pumps are of the variable displacement type and fitted with a pulsation damper for maximum reductions in pulses and noise.

A power saving device incorporated into the Framo control system automatically regulate and share the load between each power pack in operation.

Control

The hydraulic power unit and all cargo pumps and other consumers are operated and monitored from the Framo control panel.

The control system can be interfaced with ships Integrated Control System.

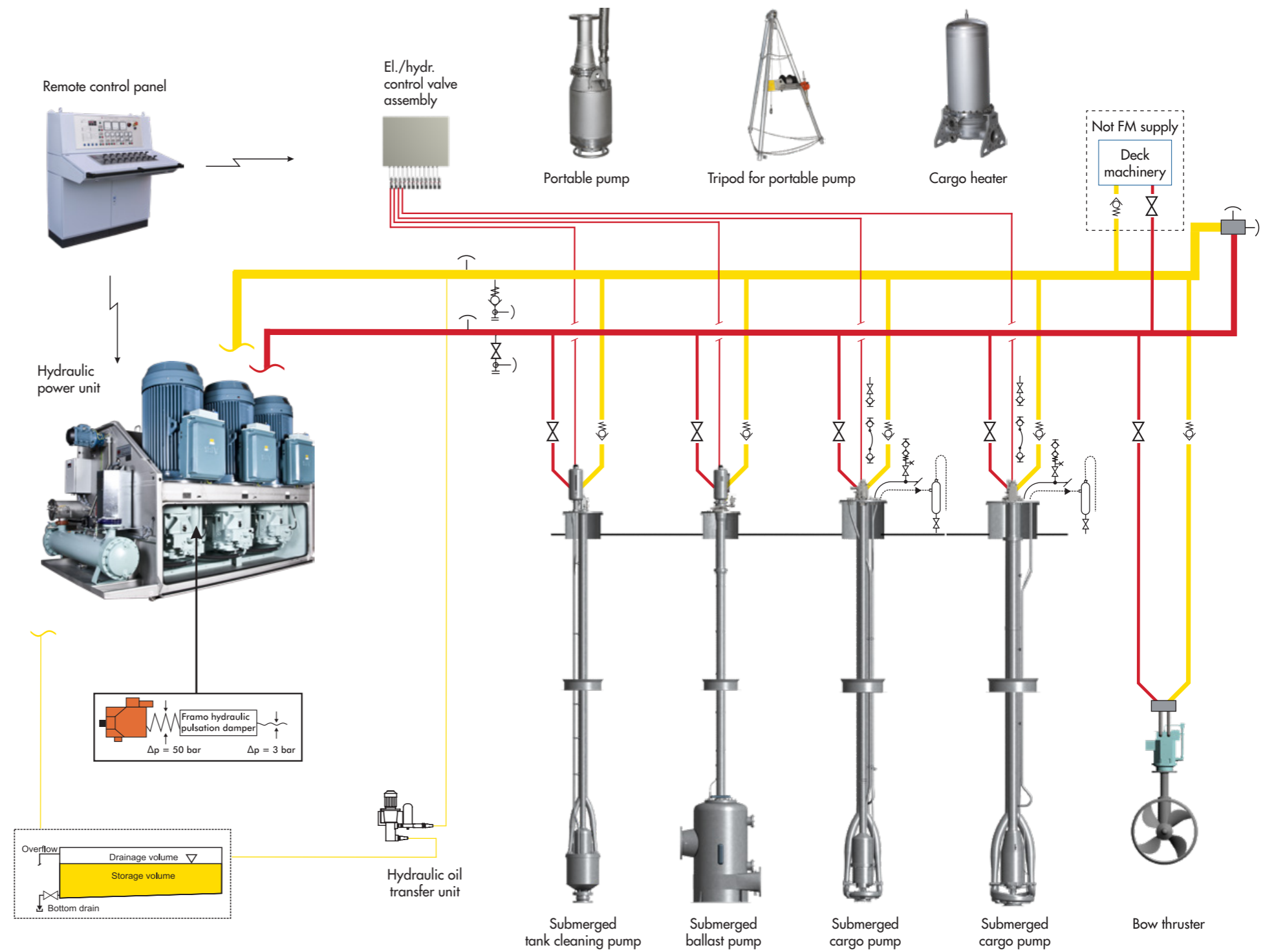

Hydraulic power unit with electric motor driven power packs for small and medium sized tankers.

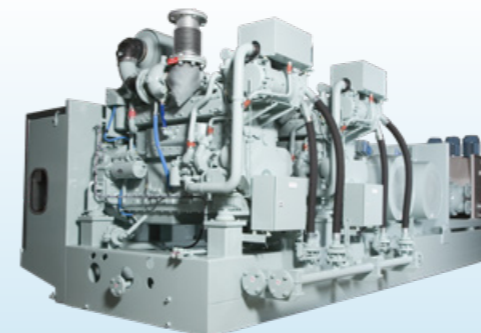

Hydraulic power unit with a combination of electric motor driven power packs and diesel engine driven power packs for medium and large sized tankers.



Hydraulic power unit with high voltage electric motor driven power packs for FPSO and FSO applications.

FRAMO PIPING

The need for quality hydraulic installation onboard vessels operating in severe marine environment has led to the development and manufacturing of Framo hydraulic piping systems. The hydraulic piping system is based on high quality components and piping materials.

BUNKER TANKERS

Bunker tankers with an increased number of cargo segregations, equal to that of product/chemical tankers, provide safe handling of multiple fuel qualities. New regulations on marine fuel quality require ships to bunker several grades of fuel to meet the legal requirements in different emission zones.



M/T "TATIANA-B" 3.500 tdw product/chemical tanker
Owner Maritima, France
Built STX Braila, Romania 2008.

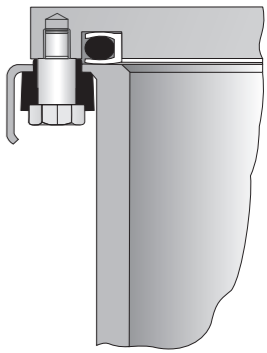
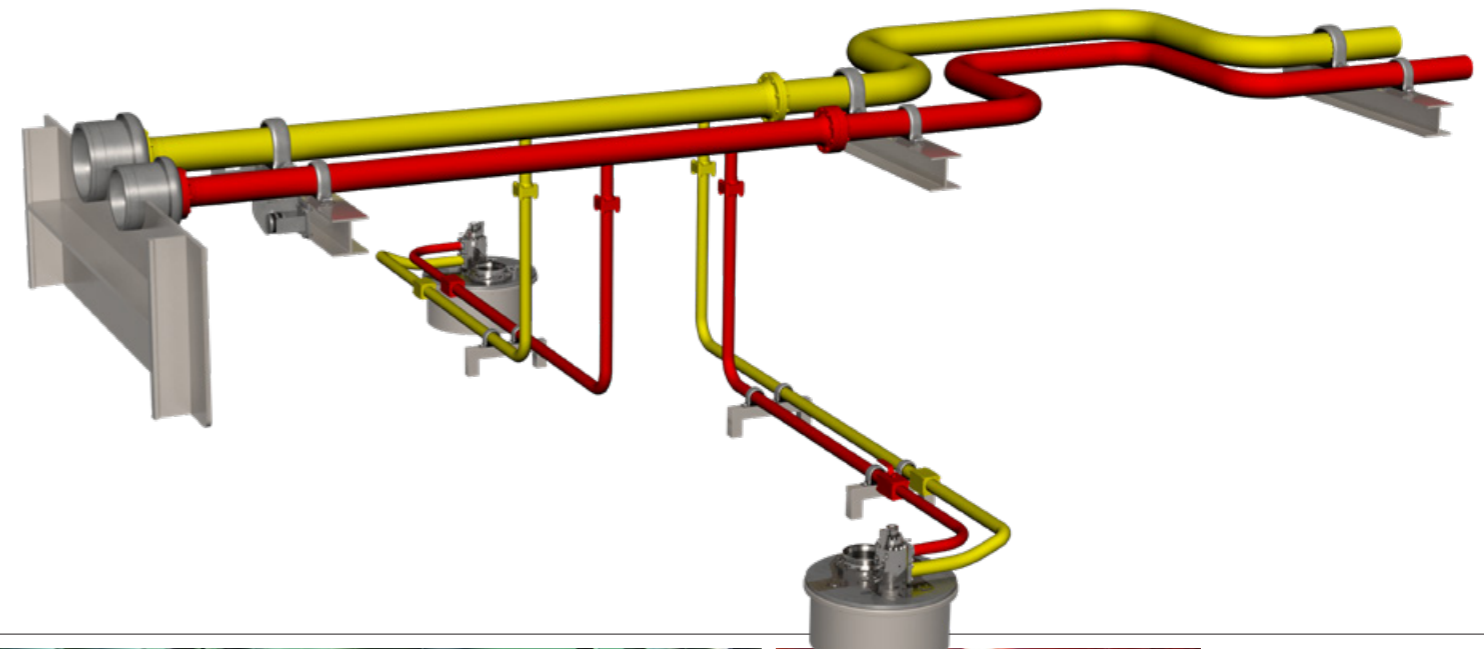

Quality and competence

Duplex stainless steel on all high pressure branch pipes and pilot pipes on deck. Stainless steel AISI 316L on all low pressure hydraulic pipes on deck.

The hydraulic pipes are of high standard with smooth internal surface intended for hydraulic oil with high cleanliness. All service valves are made from stainless steel.

The Framo hydraulic piping system is designed with extensive use of cold bending in order to limit the number of flanged connections.

Framo supply specially designed flanges for all pressure ratings, flexible bulkhead penetrations, resilient pipe clamps, anchor supports, and other accessories for the hydraulic piping system.

Framo AS has a highly specialized manufacturing plant in Norway for the design and manufacture of all the components in the hydraulic piping system.

Prefabrication of the piping system to any level of complexity from a single spool piece to a full system is available.

In all areas of design special attention is given to reduce vibration and noise from components and pumps. The cargo pumps, hydraulic power units and hydraulic piping are all resilient installed.

M/T "ELKA ATHINA" 102.500 tdw product tanker.
Owner European Navigation, Greece.
Built Brodosplit Shipyard, Croatia 2004.



CARGO PIPING

The cargo piping arrangement depends on the type of vessel, the cargoes carried and the number of segregations required. In close cooperation with shipowner and yard Framo can assist in designing an optimal cargo piping layout. A functional system should not only be designed with the purpose of a quick loading and discharge operation, but also provide for efficient draining and cleaning.

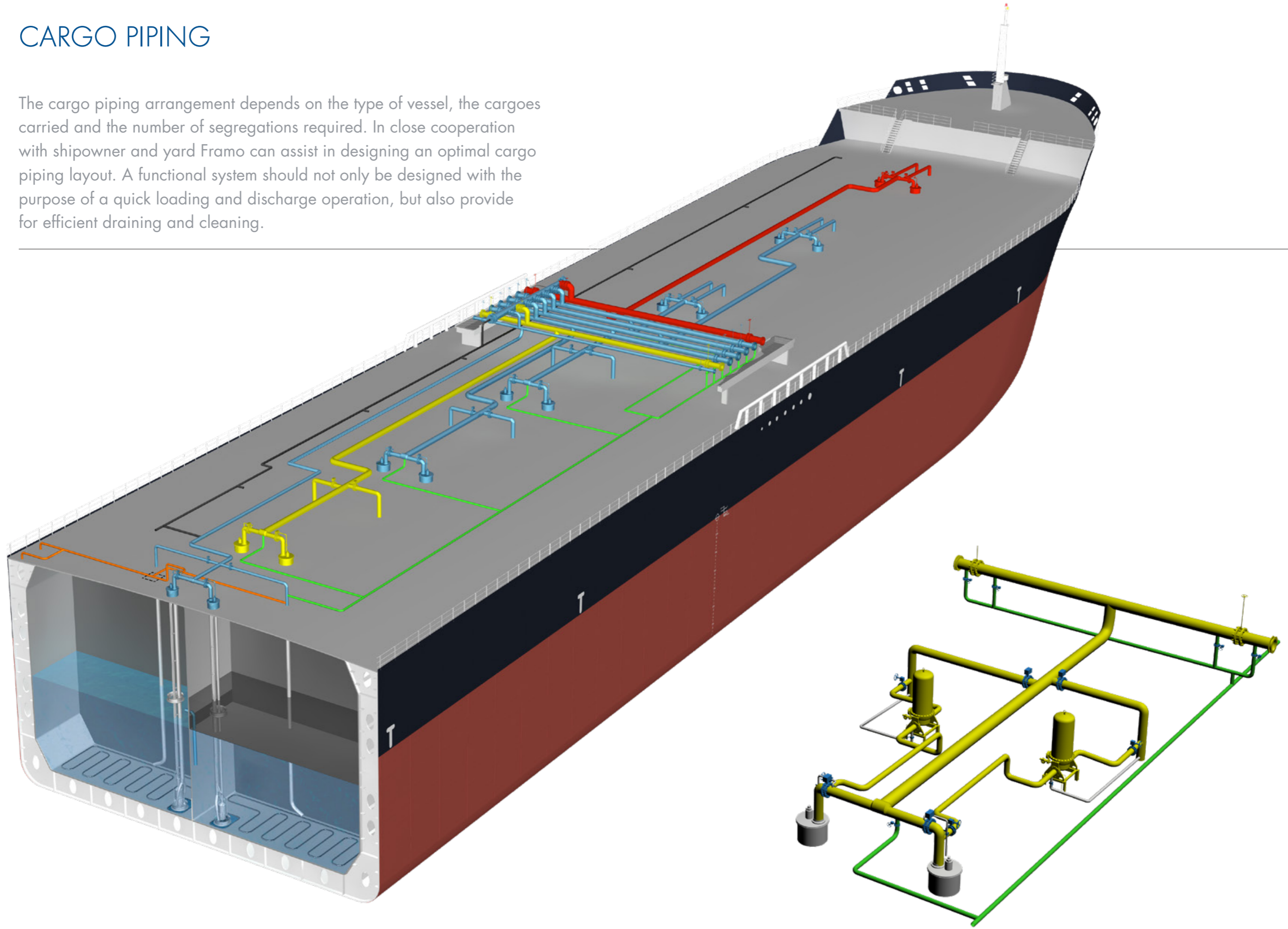

CARGO COOLING

The Framo cargo cooling system enables chemical carriers to also transport low-boiling-point cargoes and semi-gases. Cargoes such as Propylene Oxide and Isoprene are often transported on board chemical carriers, which use our cooling system to maintain a safe cargo temperature.



The Framo cargo cooling system

Comprises individual cargo coolers for each tank, chiller units and a ring-line for the cooling medium. The cargo cooler is installed submerged inside the cargo tank and is equipped with an integrated cargo circulation unit. The Framo cargo cooling system is an independent system that easily can be retrofitted.

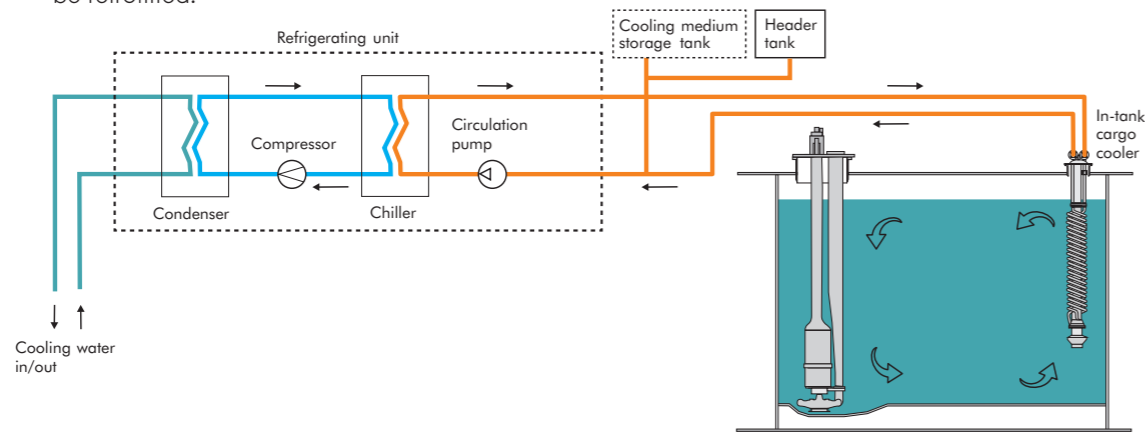
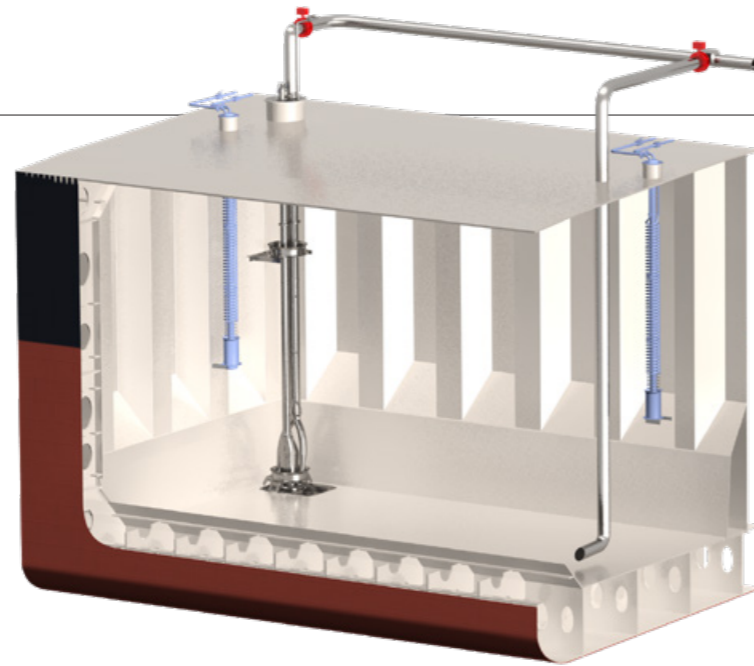

Installed inside the tank for maximum safety. Cargoes such as Propylene Oxide and Isoprene should not be circulated outside their tanks.

M/T "RABIGH SUN" 35.500 tdw chemical tanker. Owner Iino Kaiun, Japan. Built Kurushima Onishi, Japan 2008.



CARGO CIRCULATION

To prevent sediments settling on the tank-top during transport and to maintain the liquid quality, a Framo diffuser can be installed on the outlet of the dropline. During voyage cargo is circulated through the diffuser by running the cargo pump at intervals.

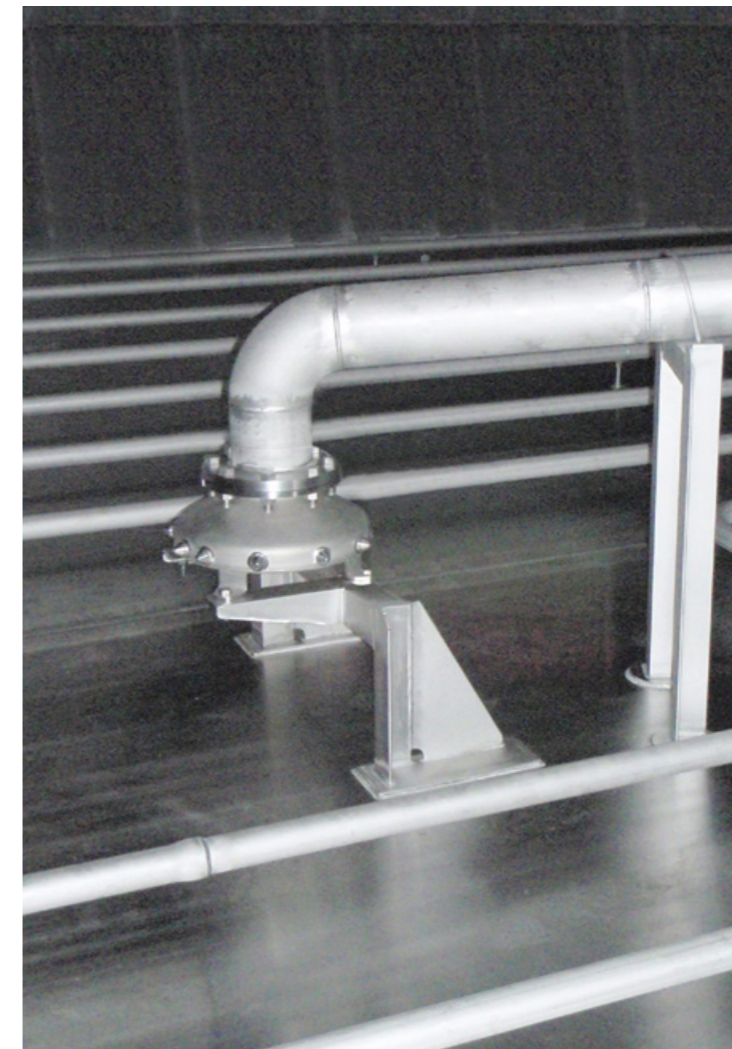

Framo diffusers

The diffusers are specially designed for individual cargo tanks, and each diffuser contains several nozzles, whose number and dimensions are determined on the basis of the dimensions and shape of the tank-top.

Diffusers are normally produced in high-molybdenum stainless steel for exposure to Phosphoric Acid, but are also available in AISI 316L for other cargoes. Forced cargo circulation should be repeated at regular intervals throughout the voyage.

OBO CARRIERS

A one-pump-per-hold system that is easy to operate and to clean has been specially designed for combination vessels that are alternating between wet and dry cargoes. The cargo pumps are installed in protective enclosed corrugations between the holds. Cargo piping and cargo heaters are located on deck.



M/T "SKS MERSEY" 121.000 tdw OBO carrier. Owner Kristian Gerhard Jebsen, Norway. Built Hyundai Heavy Industries, Korea 2003.

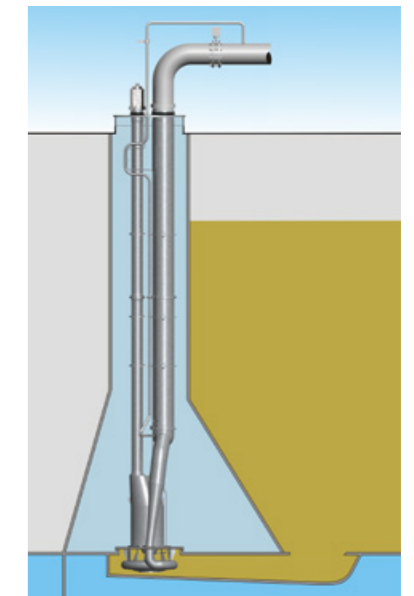

Installation

The OBO cargo pump is installed in a closed corrugation at the aft end of each cargo hold. Only the volute casing of the pump is submerged in cargo inside a suction well, with a free-flow duct connection to the cargo hold. The upper part of the pump-head and the complete pipe-stack remain dry within the corrugation, which may be regarded as a standard cofferdam.

FLOATING PRODUCTION, STORAGE AND OFFLOADING

FPSOs are producing oil in remote offshore areas under harsh environmental conditions. The highest standards for safety and operation regularity apply to designs and equipment. A reliable cargo offloading system on the FPSO is key to return on investment.

FPSOs produce revenues of substantial magnitudes.

A reliable cargo offloading system makes a difference.

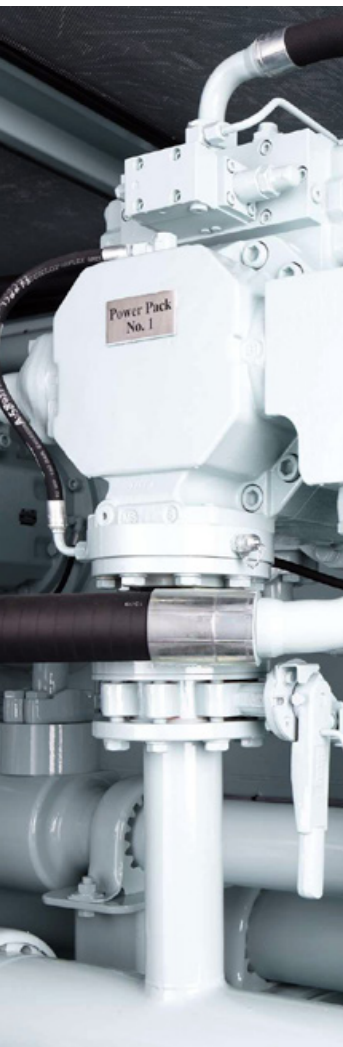

FPSO "DALIA" 2 mill bbls for Elf Exploration Angola (Total). Built Samsung Heavy Industries, Korea. Service at Dalia field in Angola since 2006.



FPSO "BONGA" 2 mill bbls for Shell Nigeria. Built Samsung Heavy Industries, Korea. Service in Nigeria since 2005.



FPSO "BOHAI BAY QHD 32-6" 1 mill bbls for CNOOC/Texaco. Built Dalian New, China. Service in China since 2001.



FPSO "P-54" 2 mill bbls for Petrobras. Conversion VLCC. Service in Brazil since 2008.



Safety and operation regularity

Framo submerged offloading pumps use a hydraulic drive technology developed through extensive experience from the tanker industry and further refined for FPSO applications.

The hydraulic motor is located close to the impeller, connected with a short rigid shaft. The motor and shaft assembly is continuously lubricated and cooled by the hydraulic drive oil.

This is a design that provides a technical sound construction that allows for transmission of high pumping power and that is suitable for very deep storage tanks.

The Framo offloading pumps are equipped with stepless capacity regulation, ensuring that the pump capacity always can meet any variations of pumping requirements on the FPSO.

In-tank offloading pumps provide safe offloading conditions. Pump room and in-tank suction lines are avoided. Each tank is effectively isolated for safe tank entry. International classification societies and regulative bodies advise the use of submerged offloading pumps for FPSOs.

Design requirements

- 100 - 200.000 bbls/day production rate
- 10 - 30 years field operation
- Offload crude oil at required flow rate
- Crude oil transfer between any storage tanks
- Pump produced water and skim oil from settling tanks
- Allow for COW during transfer or offloading
- Effectively drain the storage tanks when required

Hull process pumps

In addition to crude offloading service, the Framo submerged cargo pumps are used for continuous pump duties for in-hull processing.

Continuous transfer of:

- oil from wash tanks to settling tanks
- settled water from wash tanks/settling tanks to process
- stabilised oil to storage tanks
- methanol, MEG etc.

Desalting wash tanks and continuous settling tanks equipped with separate in-tank pumps for produced water and oil provides for an advanced and cost efficient processing.

TECHNICAL DATA

CARGO PUMPS

	A (in mm)	B (in mm)	C (in mm)	D (in mm)	CARGO FLANGE	WEIGHT of 10 m pump	WEIGHT pr m
SD 100	318	30	394	500	DN100	325 kg	20 kg
SD 125	448	30	524	500	DN125	503 kg	28 kg
SD 150	496	30	574	500	DN150	558 kg	30 kg
SD 200	635	40	715	500	DN200	963 kg	46 kg
SD 250	710	60	810	500	DN250	1153 kg	53 kg
SD 300	796	65	910	500	DN300	1600 kg	65 kg
SD 350	1000	100	1100	500	DN350	2247 kg	80 kg

CAPACITY RANGE CARGO PUMPS

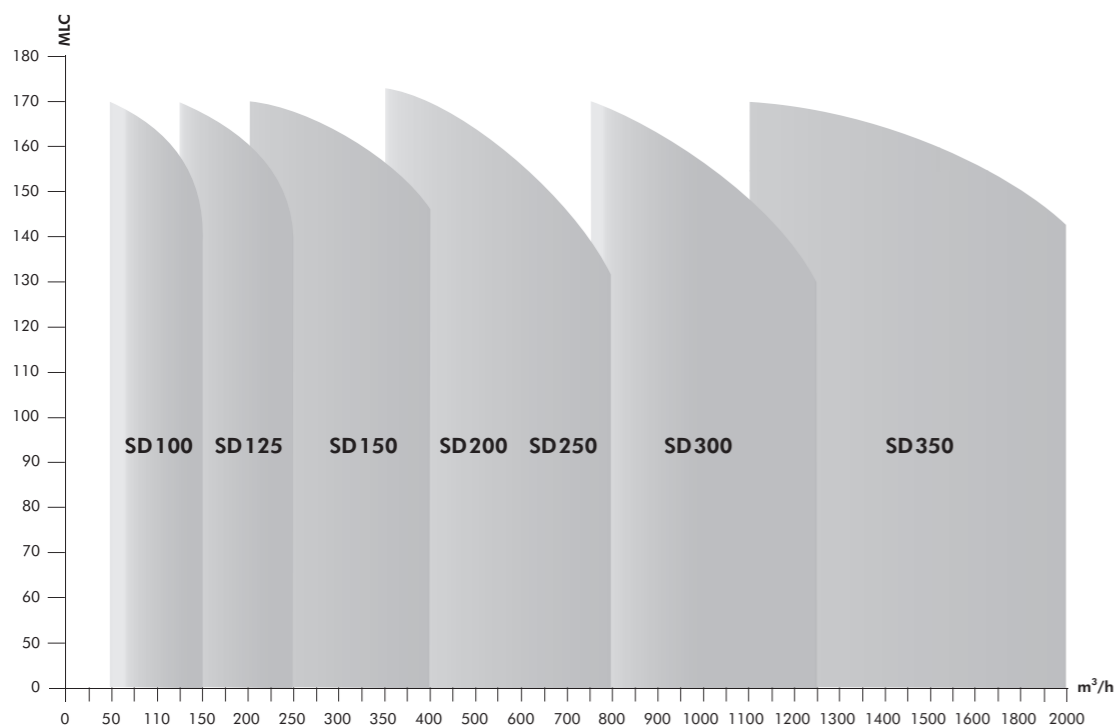

STAINLESS STEEL QUALITIES

DESCRIPTION	CHEMICAL COMPOSITION % (MASS)							APPROXIMATE EQUIVALENT		
	C MAX	Si MAX	Mn MAX	Cr	Ni	Mo	Cu	USA AISI	EUROPE EN	JAPAN JIS
Standard acid resistant	0,05	1,0	2,0	16,5 18,5	10,5 13,0	2,5 3,0	-	316	1.4436	SUS 316
Standard acid resistant low carbon content	0,03	1,0	2,0	16,5 18,5	10,5 13,0	2,5 3,0	-	316L	1.4432	SUS 316L
Special acid resistant high nickel content (2 RK 65)	0,02	0,7	2,0	19,0 21,0	24,0 26,0	4,0 5,0	1,2 2,0	904L	1.4539	

SUCTION WELLS



Stainless steel suction wells pressed to shape are available as an option.

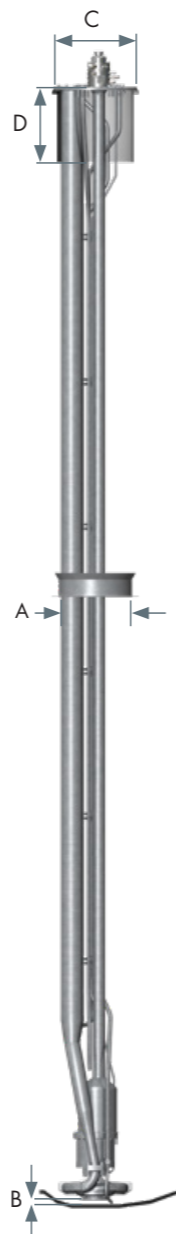

BALLAST PUMPS

	CAPACITY	A (in mm)	B (in mm)	C (in mm)	D (in mm)	WEIGHT of 10 m pump	WEIGHT pr m
SB 200	500 m³/h	790	596	250	200	510 kg	15 kg
SB 300	1000 m³/h	1463	896	350	300	1060 kg	30 kg
SB 400	2000 m³/h	1630	1100	450	400	1540 kg	30 kg
SB 600	3000 m³/h	1710	1250	600	500	2100 kg	30 kg

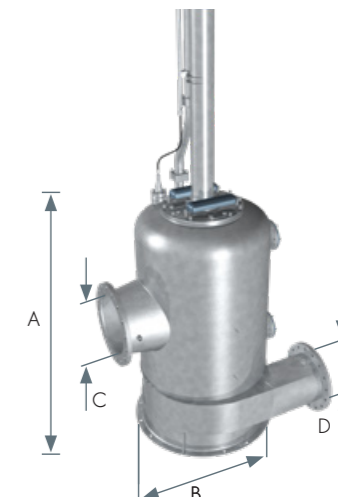

CARGO HEATERS

	CAPACITY	A (in mm)	B (in mm)	C (in mm)	WEIGHT
HE 225	360 kw	1200	366	100	175 kg
HE 430	800 kw	1600	560	160	425 kg
HE 500	1600 kw	1637	700	160	500 kg

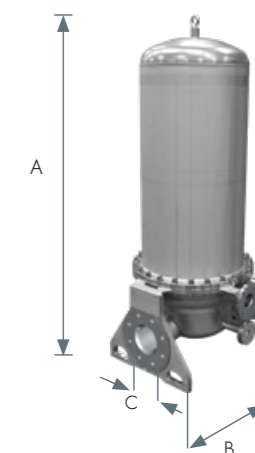

PORTABLE PUMPS

	TK 80	TK 150	TK 6	LN 150	TK 125
CAPACITY	70 m³/h	300 m³/h	500 m³/h	150 m³/h	50 m³/h
HEAD	70 mwc	60 mwc	40 mwc	45 mwc	10 bar
MATERIAL	AISI 316L	AISI 316L	Al	AISI 316L	Al
WEIGHT	25 kg	78 kg	85 kg	76 kg	86 kg
PUMPHEAD	ø250 mm	ø300 mm	ø520 mm	ø300 mm	ø300 mm
HEIGHT	625 mm	598 mm	640 mm	595 mm	1000 mm

The Framo cargo pumping system is equipped with a portable pump type TK80 or TK150 in accordance with class requirements for "a secondary means of unloading".

Hydraulic drive outperforms any other power transmission for pumping extremely viscous cargoes. For emergency cargo unloading, an extended range of portable pumps models and hydraulic power units is available for rental.



All pumps are individually run and tested with respect to capacity, head, hydraulic pressure and oil flow. The Framo system is delivered according to the requirements of any classification society and national or international maritime authorities.

RESEARCH AND DEVELOPMENT

Framo aim to supply the safest cargo pumps there are, designed for handling the most difficult cargoes carried on tankers. Excellent performance will contribute to the improved profit for owners and charterers.

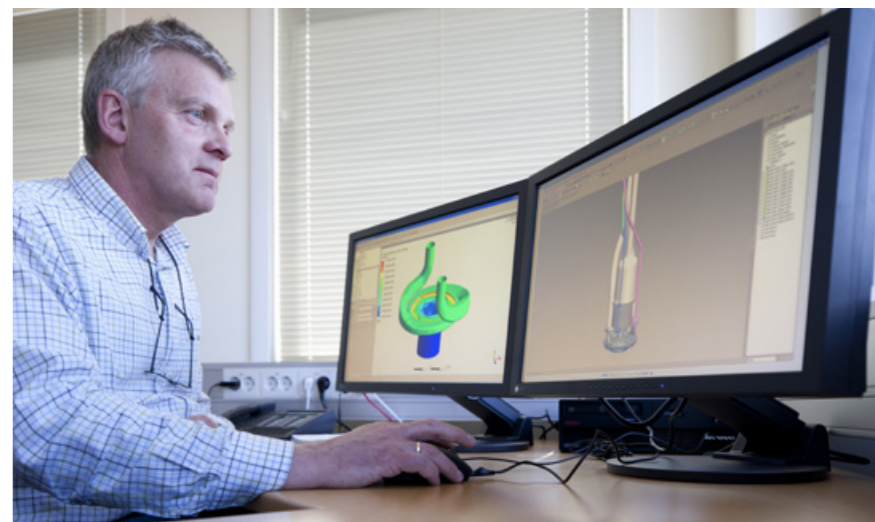
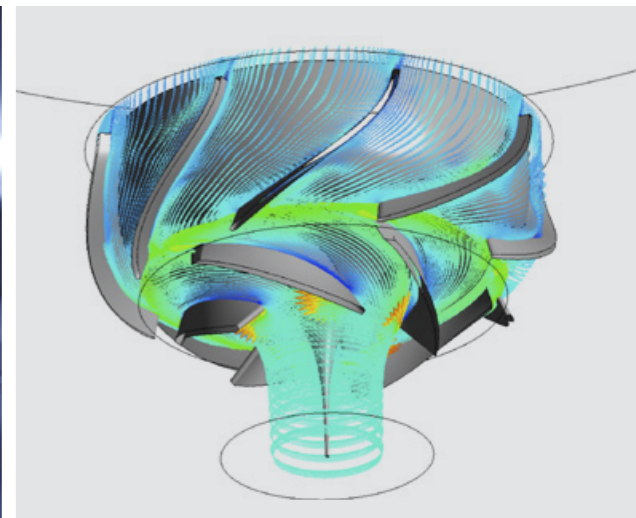

Safeguarding future improvements

Research and extensive testing is the very foundation for the development of Framo cargo pumping systems for tomorrow. The tanker industry's operational and safety requirements, as well as international maritime legislation, are getting stricter by the years. The awareness of the hazards of carrying liquid cargo in bulk, and the potential damage it can cause to people and environment in case of an accident has become a top priority issue.

Performance

We have a fully integrated company securing high and uncompromised quality in all areas of our business. We continuously work to improve system performance and reliability. In close dialogue with our customers world wide we learn and benefit from their vast operational experience from ships in service.

Testing

Full scale testing facilities and our in-house dry dock with stainless steel deep tanks give us the advantage of special testing or testing out new ideas in full.

CUSTOMER SUPPORT

Framo AS service organization provides technical support during the installation phase of a project, as well as professional service throughout the lifetime of the vessels. Condition based maintenance and correct operation are the best ways of ensuring optimal equipment performance. The Framo service organization is there to support you 24/7.



M/T "BRIMANGER" 46.000 tdw chemical/product tanker. Owner Westfal Larsen, Norway. Built Hyundai Mipo Dockyard, Korea 2009.

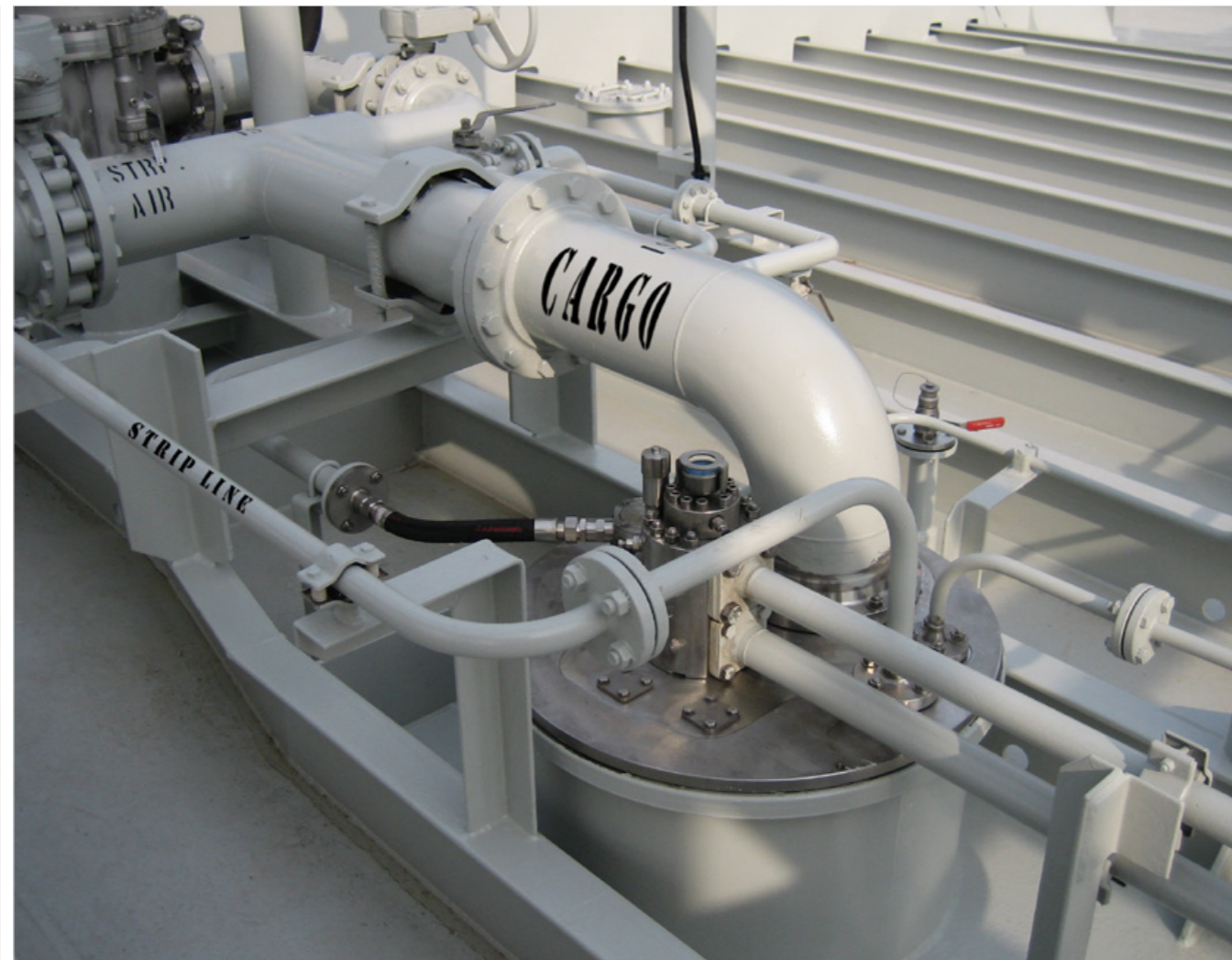

Commissioning

Framo engineers provide assistance and guidance during installation of the cargo pumping system at the shipyard. Installation, start-up and testing of the system is carried out under our supervision in close co-operation with the yard and the ship owner.

Training

Framo Training School organizes seminars and tailor-made courses at Framo training facilities in Bergen, Rotterdam, Houston, Singapore, Pusan, Tokyo, Shanghai and at the Norwegian Training Centre in Manila.

Framo seminars qualify the participants for a course certificate. The Framo programme also comprises training at the yard upon vessel delivery as well as on-board training.

Service bulletins

Technical updates are distributed to help owners and operators to best utilize the installed Framo Cargo Pumping System.



Service and repairs

To safeguard a high system availability, annual inspection, pre-docking inspection and hydraulic oil monitoring program can be provided.

Advisory service in connection with system operation, service or repair is available.

Framo engineers are available when required.

Spare parts

Our own service and repair facilities located in Bergen, Rotterdam, Houston, Singapore, Busan, Tokyo, Shanghai and Rio de Janeiro have spare parts in store to suit all the Framo systems in operation.

Condition based exchange of wear and tear parts reduces your operation cost and ensures that your cargo pumps perform with optimal capacity at all times.

We are available around the clock.

FOUNDED IN 1938

We at Framo AS take a long term view on customer relations. We shall actively cooperate with our customers, be someone to trust, with experience and competence. Through continuous research and development we are preparing for tomorrow. Framo AS is a part of Alfa Laval and is the centre of marine pumping systems within the Alfa Laval group.



positioned *globally*
support *locally*
quality pumps

made in Norway





Head office: P.O. Box 23, NO-5329 Florvåg, Norway, Phone: + 47 55 99 90 00, Telefax: + 47 55 99 93 80, E-mail: marine@framono.no

FRAMO Nederland, Edisonweg 18, P.O. Box 305, NL-3200 AH Spijkenisse, The Netherlands, Phone: + 31 181 619311, E-mail: fm.nederland@framono.no

FRAMO USA, 3002 East 13th Street, La Porte, Texas 77571, USA, Phone: + 1 281 884 4800, E-mail: fm.houston@framono.no

FRAMO Singapore, 17 Tuas View Circuit, Singapore 637575, Republic of Singapore, Phone: + 65 6210 2400, E-mail: fm.sin@framono.no

FRAMO Japan, Kotsu Building 5F, 15-5, Shinbashi, 5-chome, Minato-ku, Tokyo 105-0004, Japan, Phone: + 81 3 5776 2405, E-mail: fmnippon@framono.co.jp

FRAMO Korea, Rm 608, Centum Sh Valley, 35, Centum Dong – Ro, Haeundae – Gu, Busan, Korea, 612-020, Phone: + 82 51 743 6942/3, E-mail: fmk@framorsk.com

FRAMO Shanghai, Building No.5, 123, Lane 1165, Jin Du Road, Min Hang District, Shanghai, China 201108, Phone: + 86 21 6115 5000, E-mail: fmcn@framono.com.cn

FRAMO Brasil, Av. Presidente Vargas, 463 /19º andar, Rio de Janeiro - CEP 20071-003, Brazil, Phone: + 55 21 2507 7898, E-mail: framobr@framobr.com.br

FRAMO México, Francisco Petrarca 223-901, Col Chapultepec Morales, CP 11560 México DF, Phone: + 52 55 63 91 22 15, E-mail: mexico@framono.no

FRAMO Services AS, P.O. Box 44, NO-5329 Florvåg, Norway, Phone: + 47 55 99 92 00, E-mail: service@framono.no

FRAMO Fusa AS, Venjanaset, NO-5641 Fusa, Norway, Phone: + 47 55 99 96 00, E-mail: marine@framono.no

FRAMO Holsnøy AS, Rosslandsvegen 933, NO-5918 Frekhaug, Norway, Phone: + 47 55 99 75 00, E-mail: piping.marine@framono.no

FRAMO Flatøy AS, Flatøyvegen 24, NO-5918 Frekhaug, Norway, Phone: + 47 55 99 94 00, E-mail: oil&gas@framono.no