



# mesa<sup>3</sup>

OWNER'S MANUAL

Copyright © August 2021 Juniper Systems, Inc. All rights reserved. Information is subject to change without notice.

Juniper Systems® is a registered trademark of Juniper Systems, Inc. Mesa 3™ is a recognized trademark of Juniper Systems, Inc.

Windows, Windows 10, and the Windows logo are trademarks or registered trademarks of Microsoft Corporation in the United States and/or other countries.

The *Bluetooth*® word mark is owned by the Bluetooth SIG, Inc. Any use of such marks by Juniper Systems, Inc. is under license.

The names of other companies and products mentioned herein may be the trademarks of their respective owners.



**WARNING!** This symbol indicates that failure to follow directions could result in serious injury.



**CAUTION:** This symbol indicates that failure to follow directions could result in damage to equipment or loss of information.

Part Number 28374-03



tel: 435.753.1881 | web: [www.junipersys.com](http://www.junipersys.com)  
1132 W. 1700 N. Logan, UT 84321

# Contents

<b>1</b>	<b>Getting Started</b>	<b>1</b>
	Overview.....	2
	The Anatomy of the Mesa 3 .....	2
	Perform Initial Tasks.....	4
<b>2</b>	<b>Standard Features</b>	<b>7</b>
	Keypad Features.....	9
	LED Activity Indicators.....	10
	Light Sensor.....	11
	Connector Ports.....	11
	Audio Features.....	12
	Sensors.....	13
	<b>Bluetooth®</b> Wireless Communication.....	13
	Wi-Fi Wireless Networking.....	14
	Power Management.....	15
	Ctrl-Alt-Delete Function.....	17
	Mesa 3 is Locked Up.....	17
<b>3</b>	<b>Optional Features and Accessories</b>	<b>19</b>
	GPS/GNSS.....	20
	Configuring the GNSS Receiver.....	21
	Camera.....	25
	4G LTE Data Modem.....	26
	Barcode Imager.....	27
	Pistol Grip.....	32
	RFID Reader.....	33
	RS-232 Port.....	36
	Office Docking Station.....	39
	Vehicle Dock.....	41
	Battery Charger.....	43

**A Storage, Maintenance, and Recycling 45**  
Storing the Mesa 3 and Battery Pack.....46  
Protecting the Touchscreen .....46  
Recycling the Mesa 3 and Batteries.....47

**B Warranty and Repair Information 49**  
Limited Product Warranty .....50  
Complete Care Service Plans.....53

**C Warnings, Regulatory Information, Licensing 55**  
Product Warnings.....56  
Certifications and Standards.....58  
Licensing Information.....61

**D Specifications 63**

**Index 73**



# 1 Getting Started

# Getting Started

## Overview

The Mesa 3 Rugged Tablet™ from Juniper Systems has the Windows 10 Pro operating system. Standard features include a 7" display, capacitive touchscreen, keypad, *Bluetooth*, and Wi-Fi. Standard accessories include a lithium-ion battery pack, AC wall charger, hand strap, connector port cover, fine tip capacitive stylus and tether, and foam tip stylus for use in wet conditions. Optional features include a GPS/GNSS receiver, front and rear cameras, a 4G LTE data modem, and a RS-232 port.

## The Anatomy of the Mesa 3 Front and Back Features



- |   |   |
|---|---|
| <b>1</b> Notification LEDs                              | <b>9</b> Rear Facing Camera Lens, 8 MP                          |
| <b>2</b> Touchscreen and Display                        | <b>10</b> Camera Flash  |
| <b>3</b> Protective Over-molded Bumper (all four edges) | <b>11</b> Speaker   |
| <b>4</b> Microphone (one on each side)                  | <b>12</b> Battery Door Lock                                     |
| <b>5</b> Ambient Light Sensor                           | <b>13</b> Door to Removable Battery Compartment and Card Slots  |
| <b>6</b> Front Facing Camera Lens, 2 MP                 | <b>14</b> External Device Attachment Point (1 of 3 on the back) |
| <b>7</b> Keypad   | <b>15</b> Location of Internal Battery (not user accessible)    |
| <b>8</b> Power Key                                      | <b>16</b> Storage Slot for Fine Tip Stylus                      |

## Battery Compartment and Card Slots

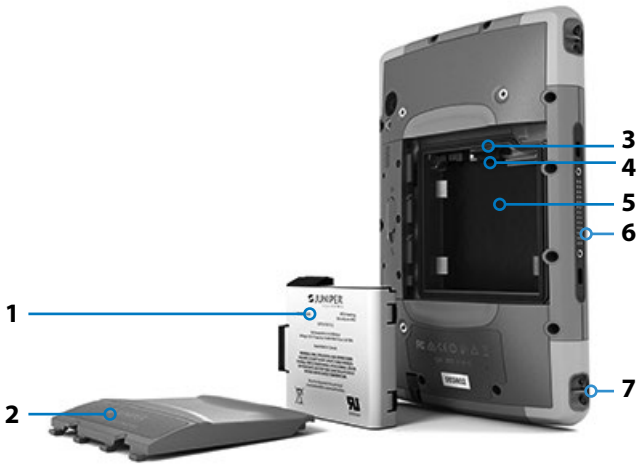

- 1** Battery Pack, Removable
- 2** Battery Door
- 3** Micro SIM Card Slot and Micro SD/SDHC Card Slot (underneath card retainer)

- 4** Flexible Card Retainer
- 5** Battery Compartment
- 6** Docking Connection
- 7** Hand Strap Attachment Point (2 on each side)

## Connector Ports



- 8** Connector Port Protector
- 9** 12 VDC Power Input Jack
- 10** USB 3.0 Host, Full Size
- 11** Audio Jack
- 12** Storage Slot for Fine Tip Stylus

## Perform Initial Tasks

When you receive your Mesa 3, perform the tasks outlined in this section before first use.

### Review Documentation

This owner's manual and other documents like release notes are available on our website at: <https://junipersys.com/support/mesa-3/documentation>. View, download, and print documents as desired, either on the Mesa 3 or another computer with an internet connection. A PDF viewer is included with your Mesa 3 apps.

### Install and Charge the Battery Pack

The Mesa 3 comes with a rechargeable and removable Li-Ion battery pack. Install and charge the battery pack as follows:

1. The battery compartment is accessed from the back of the tablet. Push the battery lock switch in, slide it to the unlocked position, and remove the door.



**CAUTION:** The Mesa 3 is not sealed against water and dust when the battery door is not installed.

2. If you are using a micro SD card for additional memory or a micro SIM card with the Cellular Data Modem (optional), you can install them now before you install the battery pack or at another time. If you do this, make sure you replace the flexible card retainer before installation of the battery. See *Chapter 2, SD Cards* or *Chapter 3, Install the SIM Card* for details.
3. Follow the graphic on the battery label to insert the battery pack properly.

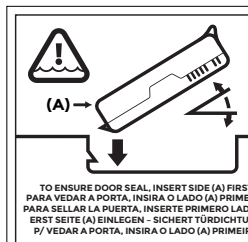

Hold the battery so that the black tab on the front edge of the battery is up and facing the door latch (this tab



helps you pull the battery out). Place the back edge in first, gently pushing it underneath the two battery catches. Rotate the front edge down until it is in position.



**CAUTION:** Do not insert the battery pack straight down. Damage to the unit could occur.



4. Replace the door and press down on it until the latch pops into the locked position.
5. Attach the appropriate plug for your country into the AC wall charger and plug it into a wall socket. Plug the other end into the DC power jack on the Mesa 3.

*Note: Use the AC wall charger that came with the Mesa 3 or another approved charger from Juniper Systems.*

6. Charge the battery pack at room temperature (68°F or 20°C) for 6 hours (for the first charge). While the battery pack is charging, the red LED blinks. When it is fully charged and external power is applied, the red LED is solid.

*Note on optional internal battery: the Mesa 3 does not recognize an internal battery until the Mesa 3 is being charged.*

## Perform Set Up

The first time the tablet is powered on, Windows setup options are shown. Follow the prompts to set up your unit as desired.

## Attach the Hand Strap and Stylus Tether

A hand strap, fine tip capacitive stylus, and tether are included with the Mesa 3.

### Hand Strap

To attach the hand strap to the Mesa 3, follow the images below. You can attach it to the right or left side of the tablet:



1



2



3

### Stylus Tether

1. Attach one end of the stylus tether to the stylus.
2. Push the free tether loop through one of the tether attachment points located on the side of any of the four corners of the Mesa 3.



3. Insert the stylus with the attached tether through this loop and tighten the loop.
4. Place the stylus into the stylus storage slot located on the bottom of the Mesa 3.



## 2 Standard Features

## Standard Features

This chapter discusses the standard features included with every model of the Mesa 3 Rugged Tablet™ with Windows 10 Pro.

### Display and Touchscreen

The Mesa 3 has a bright color display and capacitive touchscreen with a diagonal viewing area of 7 inches (178 mm).

### Display and Touchscreen Profile Settings

#### *Display Settings*

To adjust the display settings including the text size, brightness, and orientation, go to the Action Center and select *All settings > System > Display*.

#### *Backlight Brightness*

There are a few shortcuts to adjust the display backlight brightness.

Open the Action Center. Tap the percent tile (sun icon) to toggle the display backlight brightness up or down in 25% increments from 0% to 100%. This same tile can be accessed by tapping the battery icon on the desktop. To simply dim the backlight, tap the *Battery saver* tile. Tap it again to return it to the previous brightness.

#### *Touchscreen Profile Settings*

To adjust the touchscreen profile, go to the Start menu and select *Touchscreen Profiles*. Select the touch profile you want the screen optimized for: Finger and Stylus (default), Finger, Stylus, Wet, or Glove. As the new profile loads, a progress bar is shown. Do not interrupt the loading process. You can try different profiles to see which one works best.

#### *Using the Mesa 3 in Wet Conditions*

When using the Mesa 3 in wet conditions, you must use your finger or the soft-tipped stylus that is included on the capacitive touchscreen, even if the Wet touchscreen profile is selected. The hard-tipped stylus is not supported with the Wet touchscreen profile. Third party styli may work with the Mesa 3 touch screen, however, performance may vary.







### **Calibration Tool - Do Not Use**

If the Windows 10 screen calibration tool is used, it may degrade touchscreen performance.

### **Keypad Features**

The Mesa 3 has programmable keys, a power/suspend key, windows key, enter key, and a navigation pad.

The keys are sealed and have backlight illumination.

Key	Function
	Windows Start screen
p1	Volume down (programmable)
p2	Volume up (programmable)
	Move left
	Move right
	Move up
	Move down
	Enter (return)
p3	On screen keyboard (programmable)
	Power <ul style="list-style-type: none"><li>■ Press and release: On or sleep</li><li>■ Hold for 5 seconds and pull down screen: Power off</li><li>■ Hold for 10 seconds: Reset device.</li><li>■ Hold for 20 seconds: Electrically disconnect the battery pack(s); to reconnect the batteries, you are required to plug in the charger or external 12 V power.</li></ul>



## ***Programmable Keys***

The **p1**, **p2**, and **p3** keys can be configured to launch applications or functions.

To assign the programmable keys, open the Start menu and select *Keypad* (located at the bottom of the *Start menu* screen in a shortcut tile). The *Keypad Buttons and Backlight* panel appears. The programmable keys and their current assignments are shown. Select your preferred function per key from the drop down menus.

### ***Keypad Backlight Brightness***

To adjust the keypad backlight brightness, go to the Start menu and select *Keypad*. At the bottom of the *Keypad Buttons and Backlight* panel is a slider that adjusts the keypad backlight brightness. You can make the backlight brighter by moving the slider to the right or turn it down by moving the slider to the left. Dimming the keypad backlight extends battery life when the Mesa 3 is in use.

## **LED Activity Indicators**

LED activity indicators are located on the front of the Mesa 3 in the upper-left corner.

- Red LED, solid: 1) When the Mesa 3 is put to sleep or powered off by pressing the power key , the red LED is solid until the unit has successfully completed the process, and then the red LED turns off. If powering off the device, do not remove the battery while the light is solid. 2) The AC wall charger is plugged in and the battery is full (not charging).
- Red LED, blinking: The AC wall charger is plugged in and the battery is in the process of charging.
- Green LED, solid: Turns on when the system is booting, programmable.
- Blue LED, solid or blinking: Programmable.
- Amber Light: Front or rear facing camera is in use.

The green and blue LEDs are in the same location. They cannot be shown simultaneously. These LEDs can be programmed by a developer. Sample code is available upon request.

## Light Sensor

All units have an ambient light sensor located on the front of the Mesa 3 in the upper-right corner. The light sensor dynamically adjusts the backlight on the display.

You can disable this process and manually control the display brightness if you prefer. Go to the Start menu and select *Settings > System > Display*. Turn off *Change brightness automatically when lighting changes* and tap *Apply*. To manually adjust the display backlight, tap on the battery icon at the bottom of the desktop screen. The display backlight brightness can easily be toggled up or down in 25% increments from 0% to 100% by tapping the percent tile (see the sun icon).

## Connector Ports

The Mesa 3 has a 12 VDC power input jack, USB 3.0 Host type A, and a 3.5mm audio jack.

## Connector Protector

The connector protector is removable and replaceable. To remove it, pull it out of the ports, then gently pull the curved rubber retainers out of the holes they are in. Replace it by inserting the curved rubber retainers back into the holes. See your sales representative if you need a new one.

*Note: The connector protector is not required to maintain the seal of the connectors or the tablet. The connector protector is intended as a port dust cover.*

## SD Cards

The Mesa 3 has a slot for a micro SD card located in the battery compartment. The card slot and flexible card holder are designed to hold the card securely in place so it will not come out or disconnect if the tablet is dropped. To insert or remove a card, follow these steps:

1. Power off the tablet.
2. Remove the battery door as outlined in Chapter 1.



**CAUTION:** The Mesa 3 is not sealed against water and dust when the battery pack and battery door are not installed properly.



**CAUTION:** Always power off the tablet before removing the battery. Failure to do so may cause loss of data or damage to the tablet. **EXCEPTION:** If your tablet has an internal battery, this caution does not apply. You can safely remove the removable battery while the unit is running.

3. Remove the battery pack by pulling up on the black tab on the battery pack.
4. An image on the battery compartment label shows the correct location and orientation for the SD card (slot on the right). Pull the flexible card holder back out of the way. Push the card into the slot to insert it.

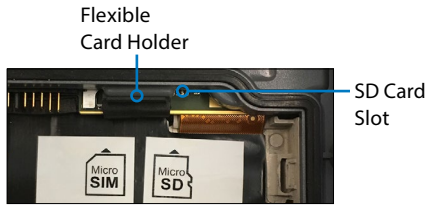

5. Push the flexible card holder back into place, covering the card slots.
6. Replace the battery pack, and attach the battery door.

To remove the SD card, pull it out. Use tape or an eraser if you have trouble.

## Audio Features

The Mesa 3 has the following audio features:

- **Speaker** - The speaker provides audible indicators and program feedback. You can listen to mono audio files and watch video. For stereo audio, use *Bluetooth*, headphones or HDMI output from the optional dock.
- **Microphone** - Use the microphones to record audio notes or include sound in a video, using the camera (option). Built in microphones can also be used for Skype calls.
- **Audio Jack** - The audio jack supports a stereo headset or headset/microphone combination with 3.5 mm connections.



## Sensors

### Compass, Accelerometer, and Gyroscope

The Mesa 3 has a built-in compass and accelerometer. The accelerometer assists the compass in determining direction, even when the device is not resting flat. The gyroscope senses change in angular motion. The compass, accelerometer, and gyroscope can also be used by other user applications.

#### Compass Calibration

The compass has been factory calibrated. Periodic user calibrations help the compass function in the environment the Mesa 3 is being used in.

1. Open an app that uses the compass.
2. Move the Mesa 3 around in the air so that it is oriented in different directions and angles. An effective way to assure this is properly done is to move the Mesa 3 back and forth in a sideways figure 8 for approximately 30 seconds.



### Bluetooth® Wireless Communication

The Mesa 3 has built-in *Bluetooth*® wireless technology, allowing you to connect it to other wireless devices with *Bluetooth* technology.

#### Creating a Partnership/Pairing a Bluetooth Device

To create a partnership between the Mesa 3 and another device with *Bluetooth* technology:

1. Turn both devices on.
2. Place them within a few feet of each other. (The Mesa has long range *Bluetooth*, but the other device might not.)

3. Make *Bluetooth* discoverable on both devices. *Bluetooth* on the Mesa 3 is off by default. To activate it, open the Action Center and press and hold the *Bluetooth* icon. Select *Go to settings*.
4. In the *Bluetooth* settings screen, you should see a list of all *Bluetooth* devices within range. Tap on the name of the device in the list you would like to pair with, then tap *Pair*. If prompted, enter the PIN or pass code of the paired device. You should now be paired with the device.

*Note: If Bluetooth is on and the tablet enters sleep or hibernate mode, Bluetooth turns off to save battery power. The connection is resumed once it powers back on.*

## **Wi-Fi Wireless Networking**

The Mesa 3 has built-in Wi-Fi wireless networking to connect to the internet or an office network.

### **Connecting to a Wi-Fi Network**

To use Wi-Fi, you need to be in range of a Wi-Fi access point to make a connection. When Wi-Fi is turned on (the default), the Mesa 3 automatically starts scanning the area for available Wi-Fi networks.

From the Action Center, click and hold the *Wi-Fi network icon*, then select *go to settings*. A list of available networks is shown. Select the network you want to use and enter the network security key. The Mesa 3 remembers the Wi-Fi network connections created.

Wi-Fi can be turned off and on and settings can be managed from this set up screen.

## Power Management

The Mesa 3 runs on battery power, using a rechargeable, Li-Ion battery pack. A non-removable, internal battery pack is an option.

### Charging the Battery Pack(s)

For instructions on how to insert and charge the removable battery pack, refer to *Chapter 1, Install the Battery Pack*.

For tablets that have both a removable battery pack and an optional internal battery pack, the intelligent internal battery charging circuit first charges the battery pack with the least amount of energy. When this battery pack comes to the same level as the other battery pack, then both battery packs are charged at the same time until they are both fully charged.

Battery packs are charged most efficiently at room temperature (68°F or 20°C). They will not charge if it is too hot or too cold.

 **CAUTION:** Only use the battery charger that came with your Mesa 3 tablet. The Mesa 3 requires a 30W or higher power supply with a 12V output to power the tablet and charge the batteries at the same time within the specified 4-6 hour time frame. Anything less will not allow the tablet to operate as specified.

### Battery Status and Management

To find out how much battery life you have left, tap on the battery icon at the bottom of the desktop screen. The amount of charge left as a percent and the status of each battery is shown. The cumulative amount of battery life left for installed batteries and the approximate amount of time battery power will last is also shown. The amount of time left varies depending on what you are doing with the unit.

### Battery Life

Battery life on a full charge can be 12 hours or more. This varies depending on whether or not you also have an optional internal battery, the applications used, backlight usage, and radio usage. The optional internal battery adds 5-6 extra hours of battery life.

The shelf life for battery packs is about one year. The battery packs should be recharged at least once per year. This prevents the battery packs from discharging to a level that might damage the batteries. Battery packs that are not recharged at least every year, could fail to work or may have reduced capacity. Battery packs typically last 1,000 to 3,000 charging cycles.

- ❗ **CAUTION:** Only use batteries designed for the Mesa 3 from an approved vendor. Use of non-approved batteries may void your product warranty. The Mesa 3 must be returned to the factory for replacement of the optional internal battery.
- ❗ **CAUTION:** The unit is not designed to run on external power without a battery installed. Doing so can damage internal components of your unit and void the warranty.

## **Powering Off the Mesa 3**

### ***Short-term Storage***

When you plug the tablet into the wall charger that comes with it, the batteries are prevented from being overcharged.

Charge the Mesa 3 to 100% then power it off:

1. Press and hold the power button for 2-3 seconds.
2. A message is shown asking you to slide the screen down to shut down your device.

### ***Long-term Storage***

To power off the Mesa 3 for long-term storage, follow these steps:

1. Power off the Mesa 3 as described in the previous section, *Short-term Storage*.
2. Press and hold the power button for 20 seconds. This disconnects the batteries from the system.
3. Take out the removable battery and store it in a cool, dry location.
4. When you are ready to power on the Mesa 3, replace the battery pack. Plug in the AC wall charger and connect it to the Mesa 3 BEFORE you power it on.

## Ctrl-Alt-Delete Function

Press and hold down the windows key, then press the power key. A list that includes the *Task Manager* is shown. Select *Task Manager* to see which apps are running. Press *More details* at the bottom to view *Processes*, *Performance*, and other items. This can be useful for troubleshooting.

## Mesa 3 is Locked Up

If the Mesa 3 is completely stuck and won't respond or you cannot get to the Start menu, hold the power key down for five seconds to see if that solves it. If that doesn't work, hold it down for 10 seconds. This causes a hardware shut off. Press the power button again to power it on.

If 10 seconds doesn't work, hold the power button down for 20 seconds. Batteries are forced to electrically disconnect from the tablet, causing a complete shut down. The tablet cannot be powered on again until it is plugged in with the AC wall charger. Keep this in mind if you are in the field.



**CAUTION:** Holding the power button down for 20 seconds for a forced disconnect is recommended only as a last resort. Forcing the power off causes all unsaved data to be lost and corrupts active data transfers to storage.





# 3 Optional Features and Accessories

## Optional Features and Accessories

This chapter discusses the optional features that can be included with the Mesa 3 Rugged Tablet.

*Note: The RS-232 connector is not available in combination with the barcode imager or the RFID reader. The NEO-M8T GNSS receiver with external antenna is not available in combination with the barcode imager or the RFID reader.*

### GPS/GNSS

Mesa 3 Geo models use an integrated GPS/GNSS receiver with an internal antenna to provide position information. Use Maps to see your location and ensure that the receiver is working. Open the Start menu and select Maps.

#### **u-blox NEO-M8T GNSS Receiver**

The u-blox NEO-M8T with an external antenna port is available as an upgrade option for GPS/GNSS in Mesa 3 Geo models. The NEO-M8T can collect data for post processing. When connected to an external GNSS antenna, the GPS/GNSS receiver will automatically detect and use the external antenna. Otherwise, the GNSS receiver will use the internal GNSS antenna.

### GPS/GNSS Support

#### ***Integrated GPS/GNSS Support in Windows***

The Windows operating system provides built-in support for GPS/GNSS devices. As part of that support, the Windows Sensor and Location platform provides a standard way for GPS/GNSS information to be made available to applications that have been designed using the Windows Sensor and Location application programming interfaces (APIs).

#### ***Legacy Support***

In addition to the Sensor and Location APIs, legacy applications that require access to a serial port can access NMEA data through a serial COM port interface. The name of the COM port can be found by using Device Manager and looking under Ports (COM & LPT) for “u-blox Virtual COM port (COMx) where “x” is the port number allocated on your device.



## Configuring the GNSS Receiver

The u-blox u-center utility can configure the internal u-blox GPS/GNSS receiver.

1. With your Mesa 3, download and install the latest version of u-center from the [u-blox website](#).
2. Find the COM port number for the Mesa 3.
  - a. Open Device Manager.
  - b. Expand the selection for "Ports (COM & LPT)." Find the u-blox COM port.

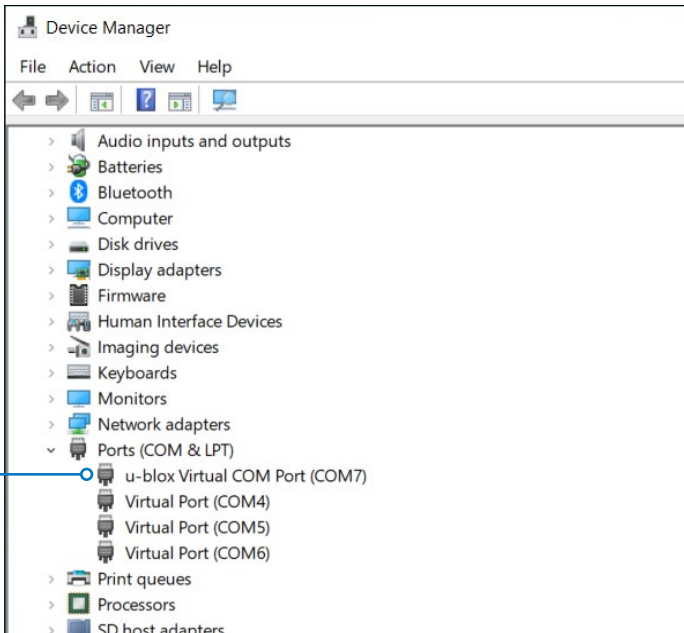

3. Open u-center.
4. Tap the arrow next to the plug icon. Select the COM Port that was identified in Step 2.

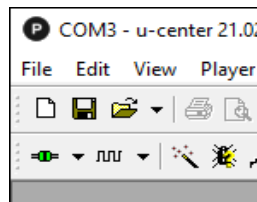

## Change the SBAS and Rate Settings

SBAS settings specify which SBAS satellites the receiver should use for GPS correction.

Rate is the amount of time it takes to update the position and output the data to the device.

To change the SBAS and Rate Settings,

1. Select **View > Configuration View**.
2. In the left column scroll down and select your desired setting.
  - SBAS (SBAS Settings)
  - RATE (Rates)

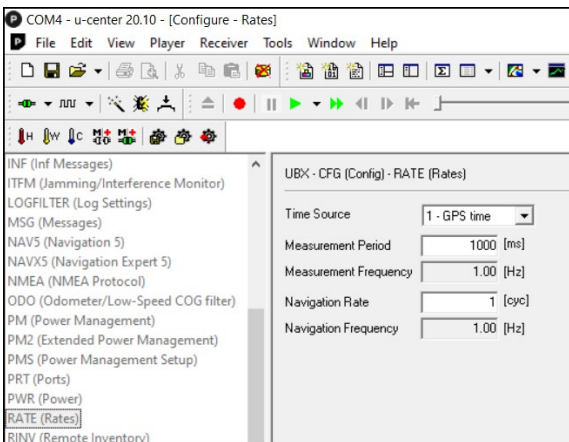
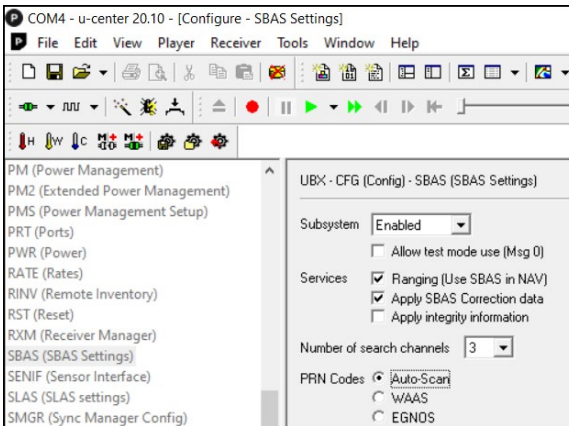

## Change the Navigation Mode

Navigation mode helps to compensate for how fast the device is moving.

1. Select **View > Configuration View**.
2. In the column on the left, scroll down to tap on NAV5 (Navigation 5).
3. Under Navigation Modes, use the drop-down menu to change the Dynamic Model to your preferred mode.

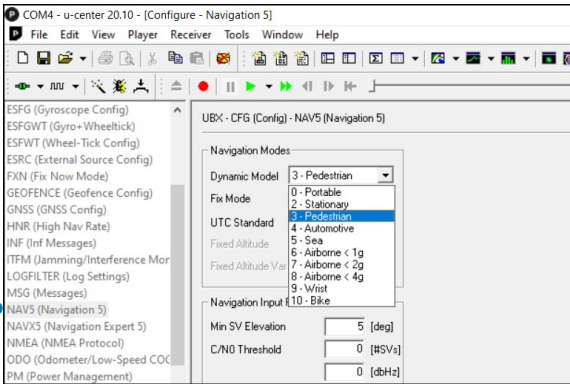

## Change the Baud Rate

The baud rate determines the speed of the data transmission.

Auto detect automatically determines the baud rate you need. To turn off auto detect,

1. Select **Receiver > Action**.
2. Uncheck **Auto Detect**.

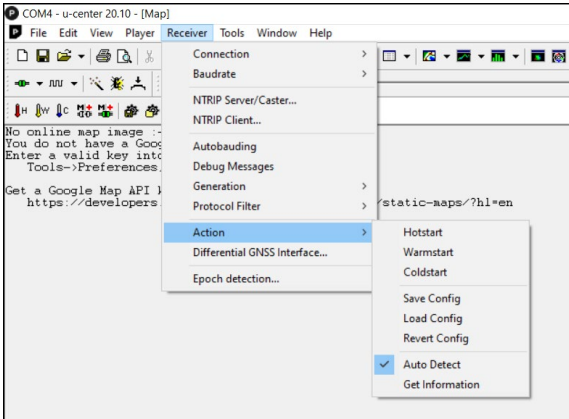

To manually change the baud rate,

1. Select **Receiver > Baud rate**.
2. Choose your preferred baud rate.

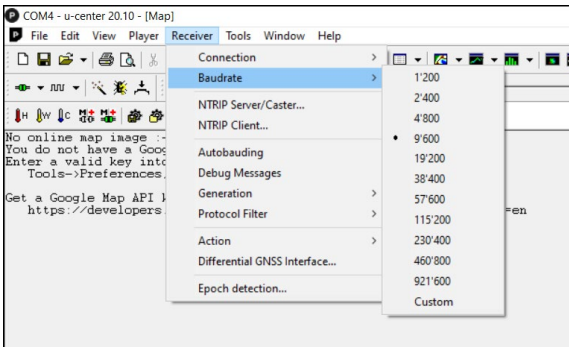

## View the Text Console

The Text Console shows the messages being sent to the GNSS receiver. To get to this screen,

1. Select **View > Text Console**.

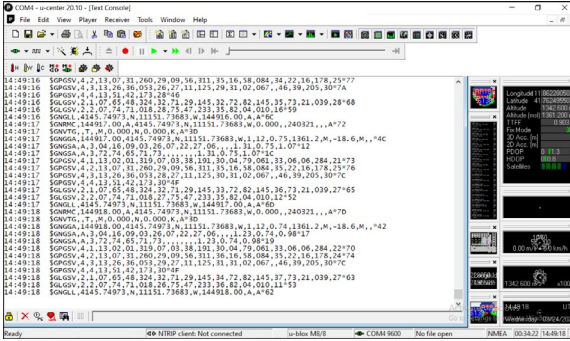

## GPS/GNSS Accuracy

The GPS/GNSS antenna in the Mesa 3 is at the top under the notification LEDs. It is intended to work in both portrait and landscape view. Do not put your hand or another object over this area. Accuracy could be reduced. The more items between the antenna and the satellites, the lower the accuracy.

## Camera

The Mesa 3 has an optional front facing camera that is 2 MP and a rear facing camera that is 8 MP.

You can capture both still images and videos using the camera application. Other options include a timer, flash, and brightness settings.

## Photo and Video Library

Photographs and videos are automatically stored in the Pictures folder.

## 4G LTE Data Modem

The 4G LTE data modem is an option for the Mesa 3, adding Wireless Wide Area Network data modem capability.

This modem supports all major service providers in North America, Europe, and many other regions of the world.

### Set up a Data Account with a Wireless Provider

Contact a wireless provider to set up data service for the cellular data modem and obtain an account and micro SIM card. You need to provide the following information when setting up an account:

1. Billing Information and business ID, such as your Federal Tax ID or VAT number.
2. The wireless services required. Specify that you need data service only. You do not need voice or messaging services.
3. You may be asked for the modem's IMEI number. From the Start menu, select *Settings > Network & Internet > Cellular*. Tap on the Cellular icon, then select *Advanced Options*. The IMEI number is listed under *Properties*.

### Install the SIM Card

The card slot and flexible card holder are designed to hold the card securely in place so it will not come out or disconnect if the tablet is dropped. To insert or remove a card, follow these steps:

1. You must power off the tablet.
2. Remove the battery door as outlined in Chapter 1.



**CAUTION:** The Mesa 3 is not sealed against water and dust when the battery door is not installed properly.

3. Remove the battery pack by pulling up on the black tab on the front of the battery pack.

- An image on the battery compartment label shows the correct location and orientation for the SIM card (slot on the left). Pull the flexible card holder back out of the way. Push the card into the slot to insert it.

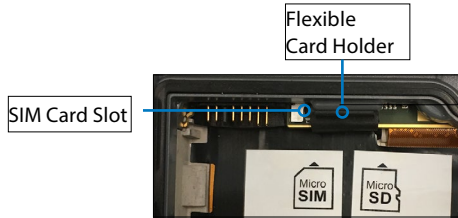

- Push the flexible card holder back into place, covering the card slots.
  - Replace the battery pack, and attach the battery door.
- To remove the SIM card, gently pull it out with tweezers or a piece of tape.

*Note: If the modem was on before shutting the Mesa 3 down to insert the SIM card, you are prompted to configure the data connection when you reboot.*

## Barcode Imager

The Mesa 3 Rugged Tablet with a barcode imager allows you to read 1D and 2D barcodes and easily import barcode data into custom or standard programs running on the Mesa 3.

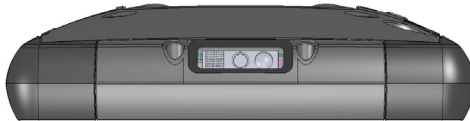

## Barcode Connector Utility

The Barcode Connector™ utility is a barcode wedge program provided with the barcode imager.

## Home Screen

When the Barcode Connector utility loads, the home screen appears. From the home screen, you can do a *Scan Test* right away. Aim the imager towards a barcode. Tap *Scan* on the screen or press the *Scan* button on the keypad (p2 is the default). When a red aiming LED appears, place it on or near the barcode. After a successful scan, the *Scan Symbology Type* and *Scan Data* are shown on the screen.

## Barcode Menu

Select the menu symbol in the upper left hand corner of the home screen or swipe the screen from left to right to see the menu (you can do this from any screen in the application). This menu gives you access to several setting screens.

## User Settings

From the menu, select *User* to open the User Settings screen. From this screen, set up options like *Barcode Scan Time* and which button to use to scan barcodes.

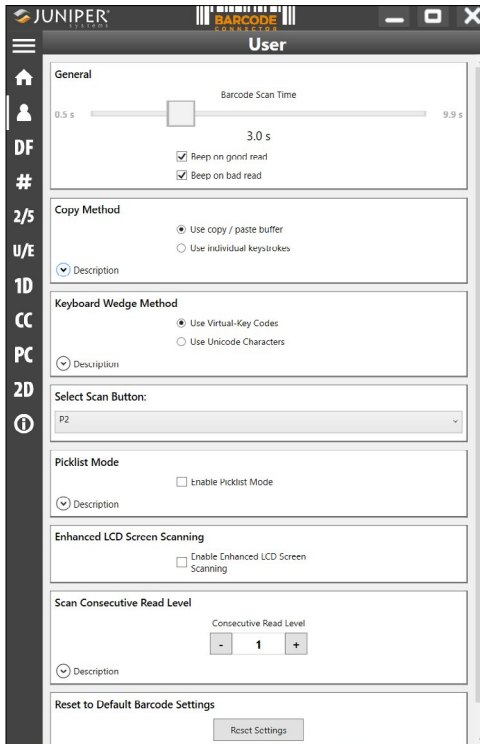



### *Data Format and Barcode Types*

On the *Data Format* screen, you can set up a prefix and suffix.

Use the rest of the menu options to set up different types of barcodes, including 1D code types, composite Codes, postal codes, and 2D code types.

### **Reading a Tag**

Now that the Barcode Connector utility is set up, you can start scanning barcodes.

1. Minimize the Barcode Connector utility.
2. Open an application or document to receive the barcode data and put the cursor where you want the data to be placed.
3. The barcode imager is located on the top of the Mesa 3 when in portrait mode. Aim the barcode imager at the barcode.
4. The distance required between the barcode and Mesa 3 varies depending on the barcode being read. There is a red aiming LED that helps you aim at the correct barcode. Press the scan button. When the barcode is successfully scanned, the barcode information is placed in your document.

### **Troubleshooting the Barcode Imager**

If the barcode imager is not functioning correctly, you can set it to factory default settings. Follow these steps:

1. Launch Barcode Connector.
2. Scan the Set Factory Default barcode, shown here.



3. Use the Reset Settings button on the User page of the Barcode Connector to restore the settings of the Barcode Connector program.
4. Close the Barcode Connector program.
5. Launch Barcode Connector and verify that correct functionality has been restored.

## Sample Barcodes

### *1D Barcodes*

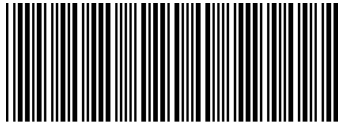

\*123456789\*

Code 39



Juniper Systems, Inc.

Code 128



0 001234 567895

UPC-A

## 2D Barcodes



Aztec

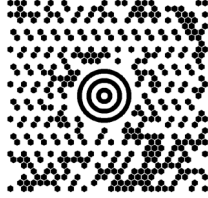

Maxicode



MicroPDF417



QR Code

## Pistol Grip

The Pistol Grip is designed to reduce strain and maximize productivity in heavy barcode scanning applications. It meets MIL-STD-810G.

*Note: Pistol grip compatibility requires that the Mesa 3 is configured with the electrical contacts on the case back.*



### How to Use the Pistol Grip

1. Place the Mesa 3 with the back facing up.
2. Line up the three screw holes and contacts on the Pistol Grip with these items on the Mesa 3.
3. Use the three screws included with the Pistol Grip to attach it to the Mesa 3.
4. Use the Barcode Connector software discussed earlier in this chapter as described.
5. The trigger has two stages. Pull it halfway back to turn the laser on and aim the barcode imager at the barcode. Pull it back fully to read the barcode.

*Note: It is not compatible with the RFID reader.*

### Holster

There is an optional nylon holster for this system that you can attach to a belt or shoulder strap.

## **RFID Reader**

The Mesa 3 Rugged Tablet with an RFID reader allows you to read UHF RFID tags and easily import data into custom or standard programs running on the Mesa 3.

## **RFID Connector**

The RFID Connector™ utility is a program provided with the RFID reader.

### ***Home Screen***

When the RFID Connector utility loads, the home screen appears. From the home screen, you can do a *Scan Test* right away. Hold the Mesa 3 with the display facing you, and an RFID tag directly away from the back of the Mesa 3. Tap *Scan* on the screen. After a tag is successfully read, the *Scan Data* is shown on the screen.

### ***RFID Connector Menu***

Select the menu symbol in the upper left hand corner of the home screen or swipe the screen from left to right to see the menu (you can do this from any screen in the application). This menu gives you access to User and Data Format setting screens.

## User Settings

From the menu, select *User* to open the User Settings screen. From this screen, set up options like *RFID Scan Time* and which button to use to scan RFID tags.

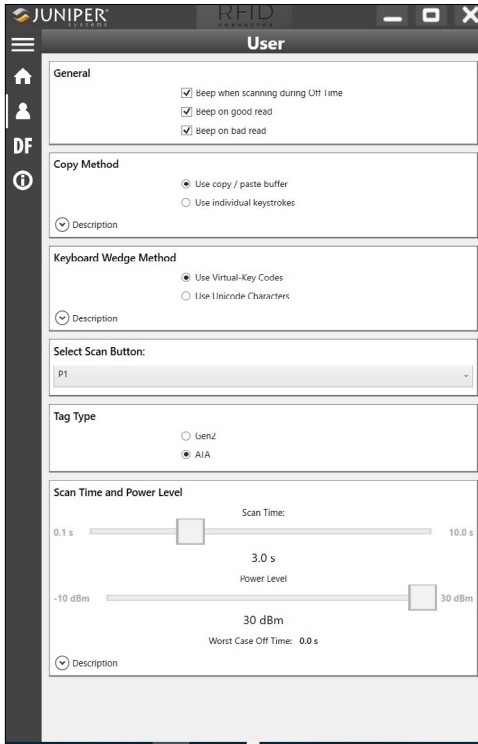

## Options

- **Scan Time:** determines the maximum time to attempt to scan for before giving up. When the scan button is pushed, the RFID scans until it finds a tag or until this amount of time has elapsed.
- **Power Level:** Sets the power level of the module.
- **Worst Case Off Time:** If the power is set higher than the regulatory threshold, this shows the maximum amount of time that the radio will remain off before it will allow another scan. The Mesa 3 regulatory threshold is the same as the maximum power of the RFID module so this number will always be zero.
- **Select Scan Button:** Allows you to select from P1, P2, or P3 as the RFID scan button. While the RFID application is running, these override what is specified in the *Keypad Control Panel*. If the RFID Connector has P1 set as the scan button, the *Keypad Control Panel* will show P1 as blank. This should not be changed from within the *Keypad Control Panel* while the RFID Connector is running. Once the RFID Connector closes, the scan button reverts back to what it was just before the RFID Connector launched.
- **Beep on good/bad read:** A sound plays when a tag is read. A different sound plays when the time has elapsed and no tag was read.
- **Startup RFID Connector on bootup:** The RFID Connector software will automatically start when the device boots.
- **Startup RFID Connector Minimized:** The RFID Connector software will automatically be minimized when it is started.
- **Use copy/paste buffer:** When this is set, the RFID data (sometimes including prefix/suffix data) is placed in the copy buffer, and then a "Ctrl-V" is simulated to paste the data wherever the user has focus.  
*Caution: The data is left in the copy buffer, so if sensitive data is being scanned, use "individual keystrokes". This method is much more snappy.*
- **Use individual keystrokes:** When this is set, every character (including prefix/suffix data) is sent as individual keystrokes.

- **Scan option:** This is a way to test your setup. When pressed, the Scan Data box is cleared and an RFID scan is initiated. An alternative is to put the cursor in the Scan Data box, and then press the button that is assigned as the scan button (P1, P2, or P3).

### ***Reading a Tag***

Open a document to receive the tag data and put a cursor in the proper location. For best read performance, hold the Mesa 3 with the display facing you, and the tag directly away from the back of the Mesa 3. The RFID reader is internal and roughly 2" to the right of the camera when looking at the back of the Mesa 3. The best orientation is portrait or landscape with Mesa 3 orthogonal or normal to the tag.

The distance required between the tag and Mesa 3 varies depending on the tag. This is not a long range reader, so you may need to be as close as a few inches and may be as far as 3 feet from the tag.

### ***Antenna for RFID Reader***

The antenna is a circularly polarized antenna. This has reduced range, but allows the Mesa 3 to be held in any orientation (linear antennas can have longer range if held in the right orientation).

## **RS-232 Port**

An RS-232 9-Pin D-Sub connector is an option for the Mesa 3. Depending on the factory configuration, it will provide either 5 VDC or 12 VDC on pin 9.

There is a RS-232 Control Panel to configure the behavior of the RS-232 port. There is a link to it on the desktop.



When you open the RS-232 Control Panel, the default configuration is shown:

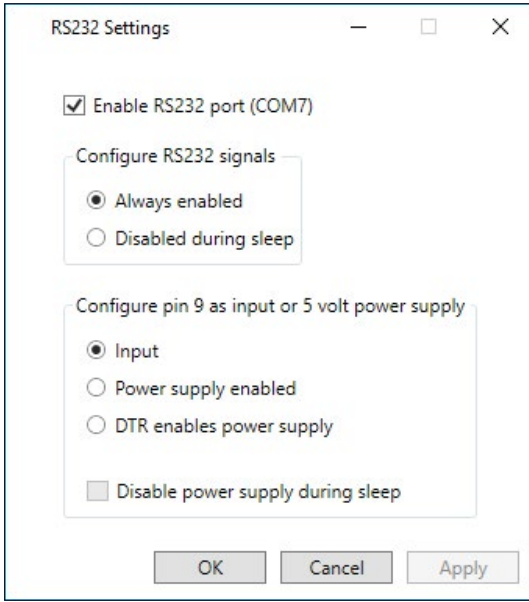

The options can be edited to suit your application:

- **Enable RS-232 port:** When it is unchecked, it powers down. When this option is checked, it powers up the RS-232 hardware. It then displays the assigned COM port number.

*Note: If you do not have a device plugged into the RS-232 port, the port pins corrode more quickly when left powered up. Use the setting to power down when it is not going to be used.*

*Note: Power consumption during sleep is higher when the RS-232 hardware is powered up.*

- **Configure RS-232 Signals:** Select *Always enabled* to have the RS-232 output signals driving and input signals enabled when the Mesa 3 is running or in sleep mode. Select *Disabled during sleep* to have the RS-232 output and input signals disabled automatically when the tablet is in sleep mode. If your app and/or RS-232 device

experiences communication failures when tablet enters or exits sleep mode, then do not use this option.

*Configure pin 9 as input or power supply: Pin 9 is the Ring-In signal input. It is rarely used by devices anymore and has become a popular pin to provide a power source to an RS-232 device.*

*Select Input if your device uses Ring-In signal or if it does not need to be powered from the RS-232 port.*

*Select Power supply enabled to make pin 9 a power supply to be used by the RS-232 device. The power supply is enabled automatically without needing any interaction with the COM port. Depending on the model, the power supply supplies either 5 VDC or 12 VDC.*

- *Select DTR enables power supply to make pin 9 a power supply (5 VDC or 12 VDC depending on model). The power supply remains off until the user application opens the COM port and asserts the DTR signal. When the DTR signal de-asserts, the power supply turns off again.*
- *Check Disable power supply during sleep to cause the power supply to automatically turn off when the tablet is in sleep mode. This can allow the RS-232 device to conserve battery power in sleep mode. If your app and/or RS-232 device experiences communication failures when the Mesa 3 enters or exits sleep mode, then leave this option unchecked.*

## Office Docking Station

The Office Docking Station enables you to perform the following functions:

- Charge your Mesa 3 Rugged Tablet
- Use your Mesa 3 as a desktop computer
- Transfer data to or from another computer or network via the Ethernet connection

### Dock Features

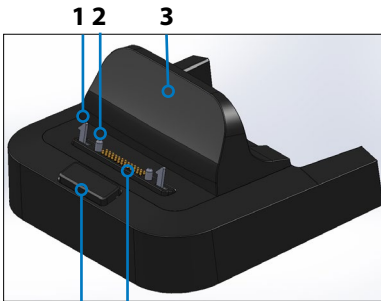

- 1 Lock Latch (2)
- 2 Alignment Pin (2)
- 3 Back Rest
- 4 Release Button
- 5 Pogo Pins
- 6 USB Ports, Host (3)
- 7 HDMI Port
- 8 Ethernet Port
- 9 Power Input Jack



6 7 8 9

### Ports

- The USB ports are for attaching devices to the Mesa 3 such as a mouse, keyboard, or external storage device.
- The HDMI port is for connecting a video monitor to the Mesa 3, giving you a second monitor.
- The Ethernet port is used for networking (an Ethernet cable is not included).

## How to Use the Dock

1. Provide power to the dock using the 30 W AC wall charger provided with your Mesa 3. A 45 W charger is available as an option, and we recommend this charger if you are using the dock as an office computer with several peripheral functions. The 30 W AC wall charger might not provide enough power to charge the batteries and run the Mesa 3.
2. Plug in the cables for your desired setup.
3. If a hand strap is covering the pin contacts on the Mesa 3, unhook one end or remove it.
4. Hold the Mesa 3 horizontally with the docking pin contacts facing down. Place it over the dock alignment pins and press down until you feel and hear the lock engage.
5. The Mesa 3 charges more quickly if the power settings are set up to allow the Mesa 3 to enter a low power mode when it is not in use, but is plugged in. To adjust this setting, go to the Start menu, then *Settings > System > Power & sleep*.

### Mounting the Dock to a Surface

The Office Docking Station is freestanding. It can also be mounted to a surface like a desk or shelf. There are keyhole slots on the bottom for this purpose.

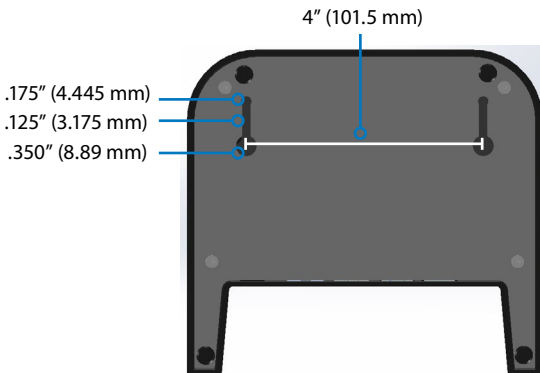

## Ethernet Specifications

- 10/100/1000 Mbps twisted-pair Ethernet
- IEEE802.3/802.3u/802.3ab 10BASE-T, 100BASE-TX, and 1000BASE-T
- Manages twisted pair crossover detection and correction
- Full-duplex and half-duplex capability (only full-duplex operation at 1000 Mbps)

## Maintenance and Environmental Issues

- The dock is intended for indoor use only.
- Temperatures should be between 0°C to 50°C.
- Avoid using the dock in situations where water can enter the connector ports. It is not sealed against water and must be kept dry.
- Do not touch the docking pins (spring loaded contacts) with conductive items when power is applied to the dock.
- Do not drop items on the dock that can damage the pins.
- Keep debris off of the docking pins.

## Vehicle Dock

The Vehicle Dock is part of a mounting system that provides the Mesa 3 with a method to be secured in a vehicle or other mobile mounting application.

*Note: There is a powered version and a non-powered version.*



## Vehicle Dock Features:

- A locking mechanism with a unique key (duplicates can be made for fleets)
- Powered dock: 12 VDC power port, vehicle charger, and USB 2.0 port (host)
- Four holes and screws for attachment to a mounting system (details follow)

## Mounting System

The Vehicle Dock does not attach directly to a vehicle. The dock attaches to any 30mm x 38mm AMPS mounting system that suits your application (sold separately). We recommend products from RAM Mounts ([rammount.com](http://rammount.com)) or ProClip ([proclipusa.com](http://proclipusa.com)).

## How to Use the Dock

1. Attach the mounting system to the vehicle. Plug the 12 V charging cable into the vehicle power port, and then into the dock.
2. If a hand strap is covering the pin contacts on the Mesa 3, unhook one end or remove it.
3. Hold the Mesa 3 horizontally with the docking pin contacts facing down. Place it over the dock alignment pins and press down until you feel and hear the lock engage.
4. Press the lock bar down until it engages the Mesa 3.
5. Push the lock button in. The Mesa 3 is now locked in the dock and cannot be accidentally removed.
6. To remove the Mesa 3, turn the key until the lock button pops out. Lift the lock bar, and remove the Mesa 3.

## Battery Charger

The Battery Charger is an optional accessory, allowing you to charge spare battery packs for the Mesa 3.

### How to Use the Battery Charger

Batteries charge best at room temperature (about 68°F or 20°C). Batteries will not charge (or might charge slowly) at temperatures below 32°F (0°C) or above 122°F (50°C).

Power the Battery Charger by using the AC wall charger provided with your Mesa 3. Slide the battery pack into the battery charger, orienting it so that the battery contacts meet the charging contacts in the battery charger. The red LED flashes slowly, indicating that the battery pack is charging.

### LED Indicator

The LED indicates the charging status:

- Solid, on: The battery pack is fully charged.
- Blinking (slow): The battery pack is charging.
- Off: There is no power. The battery is not charging.







# A Storage, Maintenance, and Recycling

# Storage, Maintenance, and Recycling

Follow the instructions in this chapter to properly maintain and recycle the Mesa 3.

## Storing the Mesa 3 and Battery Pack

When the tablet is not being charged and is in a sleep state, it draws a small amount of power. This power draw is used to maintain the memory (RAM) of the tablet in the same state it was in when it was awake. We recommend charging the tablet each night or weekend when it is in a sleep state.

If the Mesa 3 is not charged while in a sleep state and the battery reaches a low charge, it automatically hibernates to prevent further drain on the battery.

*Note: Data and programs are secure as long as they have been saved, even if the battery pack becomes discharged. The tablet does not depend on the battery to store the data for extended periods.*

## Storing the Mesa 3 for More than Two Weeks

To store the tablet for two weeks or more, complete the following steps:

1. Charge the battery pack 30 to 50 percent.
2. Close all running programs, and turn off the tablet.
3. Remove the battery pack.
4. If you have an internal battery pack, press and hold the power button for 20 seconds to disconnect it.
5. Place the battery pack in a cool, dry location.
6. The AC wall charger must be plugged in and connected to the Mesa 3 in order to turn it on after storage.

## Protecting the Touchscreen

Protect the touchscreen from impact, pressure, or abrasive substances that could damage it. To further protect the touchscreen, apply a screen protector (optional accessory) using the directions that come with it in the package.



**CAUTION:** Be sure to replace the screen protector as often as the screen protector instructions recommend.

### Cleaning the Mesa 3

Make sure the battery door is securely installed. Remove the screen protector if you want to clean underneath it. Use warm water, a mild cleaning solution, and a soft bristle brush to gently clean the Mesa 3.

- ⓘ **CAUTION:** Do not direct a high-pressure stream of water at the device to clean it. This action could break the seal, causing water to get inside the device and voiding the warranty.
- ⓘ **CAUTION:** Exposure to some cleaning solutions may damage your device, including automotive brake cleaner, isopropyl alcohol, carburetor cleaner, and similar solutions. If you are uncertain about the strength or effect of a cleaner, apply a small amount to a less visible location as a test. If any visual change becomes apparent, promptly rinse and wash with a known mild cleaning solution or with water.

### Recycling the Mesa 3 and Batteries

When the Mesa 3 and Li-Ion battery packs for your Mesa 3 reach the end of their service life, they must not be disposed of with municipal waste. It is your responsibility to dispose of your waste equipment by handing it over to a designated collection point for the recycling of waste electrical and electronic equipment.





# **B** **Warranty and Repair Information**

# Warranty and Repair Information

## Limited Product Warranty

### Two Year Warranty

Juniper Systems, Inc. ("JS") warrants that the Mesa 3 Rugged Tablet and optional internal battery shall be free from defects in materials and workmanship, under normal intended use, for a period of 24 months from the date of shipment, excepting that this warranty shall not apply to user replaceable battery packs, media containing tablet and desktop PC programs, user documentation, and any accessories.

### Ninety Day Warranty

JS warrants that the following items shall be free from defects in materials and workmanship, under normal intended use, for a period of ninety (90) days from the date of shipment:

- User replaceable battery packs
- User documentation
- Accessories

### Warranty Exclusions

This warranty shall not apply if:

- (i) the product has been set up improperly or has been improperly installed or calibrated,
- (ii) the product is operated in a manner that is not in accordance with the user documentation,
- (iii) the product is used for a purpose other than for which it was designed,
- (iv) the product has been used in environmental conditions outside of those specified for the product,
- (v) the product has been subject to any modification, alteration, or change by or on behalf of customer (except and unless modified, changed or altered by JS or under direct supervision of JS),

- (vi) the defect or malfunction results from misuse or accident,
- (vii) the serial number on the product has been tampered with or removed, or
- (viii) the product has been opened or tampered with in any way (such as the tamper evident VOID label indicating certified IP [Ingress Protection] seal area has been tampered with or removed).

Parts that are excessively worn are not covered under warranty. These may include, but are not limited to, the keyboard elastomer and switch matrix, hand straps, and the touch screen (if applicable).

This warranty is exclusive and JS will not assume and hereby expressly disclaims any further warranties, whether express or implied, including, without limitation, any warranty as to merchantability, fitness for a particular purpose, non-infringement or any warranties arising from the course of performance, dealing, or usage of trade. JS specifically makes no warranties as to the suitability of its products for any particular application. JS makes no warranties that

- its products will meet your requirements or will work in combination with any hardware or applications software products provided by third parties,
- the operation of its products will be uninterrupted or error free, or
- all defects in the product will be corrected.

JS shall not be responsible for software, firmware, information, or memory data contained in, stored on, or integrated with any products returned to JS for repair, whether under warranty or not.

## **Remedy**

In the event a defect in materials or workmanship is discovered and reported to JS within the specified warranty period, after evaluation by a technician at a certified repair center, JS will, at its option, repair the defect or replace the defective part or product. Replacement products may be new or reconditioned. JS warrants any replaced or repaired

product for a period of ninety (90) days from the date of return shipment, or through the end of the original warranty period, whichever is longer.

### **Limitation of Liability**

To the fullest extent allowed by law, the obligation of JS shall be limited to the repair or replacement of the product. JS shall in no event be liable for special, incidental, or consequential, indirect, special or punitive damages of any kind, or for loss of revenue or profits, loss of business, loss of information or data, or other financial loss arising out of or in connection with the sale, installation, maintenance, use, performance, failure, or interruption of any product. Any responsibility and/or liability of JS shall, in connection with a warranted product, be limited in the maximum amount to the original purchase price.

### **Governing Law**

This warranty is governed by the laws of Utah, U.S.A. and excludes the United Nations Convention on Contracts for the International Sale of Goods. The courts of Utah shall have exclusive personal jurisdiction in case of any disputes arising out of or in connection with this warranty.

### **Warranty Repairs**

Warranty information for the Mesa 3 Rugged Tablet is located on our website at <https://junipersys.com/support/mesa-3/my-product> then Warranty. You can check warranty status, view warranty terms and conditions, etc.

Standard repair orders and 3-Day Expedite Service repair orders are valid for 30 days from the date issued. 1-Day Expedite Service repair orders are valid for 7 days from the date issued. If you will not be sending the product to us immediately, please wait to request a repair until closer to the time when you are ready to send us the product.



### ***Services and Materials Provided Under Warranty***

- Analysis of problem by service technician
- Labor and materials required to fix defective parts
- Functional analysis performed after repair
- Shipping costs to return device to customer

JS strives to provide continued full repair services for our products for up to five years from the final production date of each product model. However, in some rare cases (depending on the repair need), it may not be possible to perform a repair due to an unforeseen discontinuation or lack of supplied parts from third-party vendors. Repair support for a product may continue beyond five years if obtaining replacement parts or tools remains economically feasible. Our policy is that we will do what is best and most beneficial for our customers and company.

### **Complete Care Service Plans**

We offer service plan options that provide additional benefits through participating repair centers. Services include:

- Service plan coverage up to five years from the original product ship date
- Up to a 50% discount on all charged repairs
- Expedited repairs and return shipping at no additional charge
- Replacement of worn and/or damaged parts at no additional charge
- Complete comprehensive coverage to protect your investment even when accidents occur
- Loaner product option when an expedited repair is not enough
- Priority support through a personal account specialist

For more information about our Complete Care service plans, go to our website at <https://junipersys.com/support/ mesa-3/my-product> then Warranty/Complete Care Options or Warranty/Complete Care Terms and Conditions.

## Repairs, Upgrades, and Evaluations



**CAUTION:** Do not attempt to repair the Mesa 3 yourself. This action voids the warranty.

Information about repairs, upgrades, and evaluations is located on our website at <https://junipersys.com/support/mesa-3/my-product> then Repairs. You can locate a repair center, submit a repair order, check repair status, view terms and conditions, get shipping instructions, and view lead times.

Before returning a unit, please get permission by submitting a repair order from our website and waiting for confirmation or by contacting a repair center directly. Be prepared to provide the following information:

- The product serial number. Information about your Mesa 3 is shown when you go to the Start menu and select *Device Info*. The serial number is located inside the battery compartment as well.

*Note: Before opening the battery door and removing the battery, see the proper procedure in Chapter 2, Power Management.*

- Name and shipping address of company/university/agency.
- Best contact method (phone, fax, email, cell/mobile).
- Clear, highly-detailed description of the repair or upgrade.
- Credit card/purchase order number and billing address (for a repair or upgrade that is not covered by the standard warranty or an extended warranty policy).

### System Information for your Mesa 3

You might be asked to provide additional information about your Mesa 3 when you contact a repair center. To view information like the operating system edition, OS build and serial number, go to the Start Menu and select *Device Info*. You can find additional information under Action Center and select *All Settings > System > About*.



# C Warnings, Regulatory Information, Licensing

# Warnings, Regulatory Information, Licensing

## Product Warnings

Follow the warnings listed below to use the M3 (Mesa 3) and accessories safely.



### Battery Warnings

**WARNING!** This device comes with a lithium-ion rechargeable battery pack. To reduce the risk of fire or burns, do not disassemble, crush, puncture, short external contacts, or expose the battery pack to fire.

Do not disassemble or open, crush, bend or deform, puncture or shred.

Do not modify or remanufacture, attempt to insert foreign objects into the battery, immerse or expose to water or other liquids, expose to fire, explosion or other hazard.

Only use the battery for the system for which it is specified.

Only use the battery with a charging system that has been qualified with the system per this standard. Use of an unqualified battery or charger may present a risk of fire, explosion, leakage, or other hazard.

Do not short circuit a battery or allow metallic conductive objects to contact battery terminals.

Replace the battery only with another battery that has been qualified with the system.

Use of an unqualified battery may present a risk of fire, explosion, leakage, or other hazard.

Promptly dispose of used batteries in accordance with local regulations.

Battery usage by children should be supervised.

Avoid dropping the battery. If the battery is dropped, especially on a hard surface, and the user suspects damage, take it to a service center for inspection.

Improper battery use may result in a fire, explosion or other hazard.



**CAUTION:** Risk of explosion if the battery is replaced by an incorrect type.



### **Wall Charger Warnings**

**WARNING!** To reduce the risk of personal injury, electrical shock, fire or damage to the equipment:

Plug the wall charger into an electrical outlet that is easily accessible at all times.

Do not place anything on the wall charger cord or any of the other cables. Arrange them so that no one may accidentally step on or trip over them.

Do not pull on a cord or cable. When unplugging the wall charger from the electrical outlet, pull on the plug, not the cord.

The AC wall charger must be approved by Juniper Systems, have an output rating of 12 VDC and a minimum 1.67 A, and be certified or listed by a nationally recognized testing laboratory. The AC wall charger provided with the Mesa 3 meets these criteria. Using any other external power source can damage your product and void your warranty.

## Certifications and Standards

There are North American, European Union, and Australian versions of the Mesa 3, with different certifications and standards.

### United States

In compliance with the FCC rules 47 CFR 15.19(a)(3), the statements that follow must appear on the device or in the user documentation.

This device complies with Part 15 of the FCC Rules. Operation is subject to the following two conditions:

- The device may not cause harmful interference.
- This device must accept any interference received, including interference that may cause undesired operation.

In compliance with the FCC rules, 47 CFR 15.105(b), the user must be notified that this equipment has been tested and found to comply with the limits for a Class B digital device, pursuant to part 15 of the FCC Rules. These limits are designed to provide reasonable protection against harmful interference in a residential installation. This equipment generates, uses and can radiate radio frequency energy and, if not installed and used in accordance with the instructions, may cause harmful interference to radio communications. However, there is no guarantee that interference will not occur in a particular installation. If this equipment does cause harmful interference to radio or television reception, which can be determined by turning the equipment off and on, the user is encouraged to try to correct the interference by one or more of the following measures:

- Reorient or relocate the receiving antenna.
- Increase the separation between the equipment and receiver.
- Connect the equipment into an outlet on a circuit different from that to which the receiver is connected.
- Consult the dealer or an experienced radio/TV technician for help.

In compliance with the FCC rules, 47 CFR 15.21, the user must be notified that changes or modifications to the Rugged Tablet that are not expressly approved by the manufacturer could void the user's authority to operate the equipment.

Only approved accessories may be used with this equipment. In general, all cables must be high quality, shielded, correctly terminated, and normally restricted to two meters in length. Wall chargers approved for this product employ special provisions to avoid radio interference and should not be altered or substituted.

## **Canada**

In compliance with Industry Canada rules, the following statement must appear on the device or in the user documentation:

This Class B digital apparatus complies with  
Canadian ICES-003.

This device complies with Industry Canada licence-exempt RSS standard(s). Operation is subject to the following two conditions: (1) this device may not cause interference, and (2) this device must accept any interference, including interference that may cause undesired operation of the device.

Canadian regulations restrict the use of channels in the band 5150 MHz to 5250 MHz to indoor use only. When this product is connected with an access point that is operating in this frequency range, or when using ad-hoc mode, the use of this product is restricted to indoor use only.

Le présent appareil est conforme aux CNR d'Industrie Canada applicables aux appareils radio exempts de licence. L'exploitation est autorisée aux deux conditions suivantes: (1) l'appareil ne doit pas produire de brouillage, et (2) l'utilisateur de l'appareil doit accepter tout brouillage radioélectrique subi, même si le brouillage est susceptible d'en compromettre le fonctionnement.

La réglementation canadienne restreignent l'utilisation des canaux dans la bande 5150 MHz à 5250 MHz pour une

utilisation en intérieur. Lorsque ce produit est connecté à un point d'accès qui fonctionne dans cette gamme de fréquences, ou lorsque vous utilisez le mode ad-hoc, l'utilisation de ce produit est limitée à une utilisation en intérieur.

### **Radio Frequency Safety**

This equipment complies with radiation exposure limits set forth for an uncontrolled environment. This equipment is in direct contact with the body of the user under normal operating conditions. This transmitter must not be co-located or operating in conjunction with any other antenna or transmitter.

Cet équipement est conforme aux limites d'exposition aux radiations dans un environnement non contrôlé. Cet équipement est en contact direct avec le corps de l'utilisateur dans des conditions de fonctionnement normales. Cet émetteur ne doit pas être co-localisées ou opérant en conjonction avec tout autre antenne ou transmetteur.

### **CE Marking (European Union)**



Products bearing the CE marking comply with the EU Directive 2014/53/EU.

CE compliance of this device is valid only if powered with/by a CE-marked wall charger provided by the manufacturer. Cables connecting to the USB host port must use a ferrite core/bead on the cable. The ferrite core must be placed on the cable near the end that connects to the Mesa 3.

### **Declaration of Conformity**

The Declaration of Conformity for CE Marking is available at: <http://www.junipersys.com/doc>



## Restricted Materials Conformity

The Mesa 3 conforms to the following restricted materials regulations:

- RoHS 2011/65/EU
- RoHS 2015/863
- REACH 1907/2006 (33)
- REACH 1907/2006 (67)
- POP 2019/1021
- Proposition 65
- Canada Prohibition
- TSCA

## Licensing Information

This Product is licensed under the AVC, the VC-1 and the MPEG-4 Part 2 Visual patent portfolio licenses for the personal and non-commercial use of a consumer to (i) encode video in compliance with the above standards ("Video Standards") and/or (ii) decode AVC, VC-1 and MPEG-4 Part 2 Visual that was encoded by a consumer engaged in personal and non-commercial activity or was obtained from a video provider licensed to provide such video. None of the licenses extend to any other product regardless of whether such product is included with this product in a single article. No license is granted or will be implied for any other use. Additional information may be obtained from MPEG LA, LLC. See [www.mpegla.com](http://www.mpegla.com).

No rights are given for Dolby patents used in the Dolby portion of this product. A list of relevant patents may be obtained from Dolby Laboratories, Inc. No rights are granted to any Dolby copyrights, including the right to reproduce or distribute any portions of this product that includes Dolby intellectual property. Licenses for these activities may be obtained from Dolby.

Any use of this product in any manner other than personal use that complies with the MPEG-2 standard for encoding video information for packaged media is expressly prohibited without a license under applicable patents in the MPEG-2 patent portfolio, which license is available from

MPEG LA, LLC, 6312 S. Fiddlers Green Circle, Suite 400E,  
Greenwood Village, Colorado 80111 U.S.A.

Windows 10 is automatically updated, which is always enabled. ISP fees may apply. Additional requirements may apply over time for updates.

Cortana experience may vary by device.



# D Specifications

## Mesa 3 Rugged Tablet Specifications

*Note: Specifications are subject to change without notice.*

FEATURE	SPECIFICATION
Operating System	<ul style="list-style-type: none"><li>■ Microsoft® Windows 10 Pro</li><li>■ English, French, German, Spanish, Brazilian Portuguese are built in; other languages are available for download</li></ul>
Processor	<ul style="list-style-type: none"><li>■ Quad-core Intel® Pentium® N4200</li></ul>
Memory	<ul style="list-style-type: none"><li>■ 8 GB RAM (LPDDR4)</li></ul>
Primary Data Storage	<ul style="list-style-type: none"><li>■ 128 GB or 256 GB flash storage (model specific)</li></ul>
Micro SD/SDXC Card Slot	<ul style="list-style-type: none"><li>■ SD/SDXC slot, user accessible</li></ul>
Physical Features	<ul style="list-style-type: none"><li>■ Dimensions, standard: 5,4" wide x 8.48" long x 1.36" thick (137 mm x 215 mm x 35 mm)</li><li>■ Weight: 1.5 to 2.2 lb (680-907 g) depending on battery configuration and internal options installed</li><li>■ Durable, chemical- and shock-resistant design</li><li>■ Easy-to-grip, impact-absorbing, overmolded bumpers</li><li>■ 3 mounting points on the back are size #4-40 UNC with a maximum depth of 3/16th" (4.76 mm)</li></ul>
Display	<ul style="list-style-type: none"><li>■ Active viewing area: 7" (178 mm)</li><li>■ WXGA 800 x 1280 pixel resolution</li><li>■ Backlit LCD</li><li>■ Outdoor viewable</li><li>■ Portrait or landscape orientation</li></ul>

FEATURE	SPECIFICATION
Touchscreen	<ul style="list-style-type: none"> <li>■ Capacitive multi-touch interface for use with gloves, small tip stylus, and in wet conditions</li> <li>■ Chemically-strengthened Dragontrail™ High Ion-Exchange (HIE™) coverglass for impact and scratch resistance</li> <li>■ Touchscreen profile options</li> </ul>
Keyboard	<ul style="list-style-type: none"> <li>■ Programmable keys</li> <li>■ Backlit keys</li> </ul>
Batteries	<ul style="list-style-type: none"> <li>■ Rechargeable Li-Ion battery pack, 7.2 VDC 6Ah, 43.2 Whr</li> <li>■ Run time of up to 12 hours or more</li> <li>■ Charging time 4 to 6 hours</li> <li>■ Built-in battery intelligence</li> <li>■ User-replaceable</li> <li>■ Optional internal 21.6 Whr battery provides an additional 50% of runtime and hot-swap capability; not user replaceable (not user accessible)</li> </ul>
Connector Ports	<ul style="list-style-type: none"> <li>■ USB 3.0 Host (full size A connector)</li> <li>■ Power input is 10 V - 15.5 V, nominal 12 VDC</li> <li>■ 3.5 mm audio jack, supports stereo headset/microphone</li> </ul>
Wireless Connectivity	<ul style="list-style-type: none"> <li>■ Bluetooth® wireless technology 5.0 long range</li> <li>■ Wi-Fi 802.11 a/b/g/n/ac 2.4 GHz and 5 GHz</li> </ul>
Audio	<ul style="list-style-type: none"> <li>■ Mono speaker, loud and clear</li> <li>■ Microphone, low noise</li> </ul>
LED Activity Indicators	<ul style="list-style-type: none"> <li>■ Red: power applied/charging status</li> <li>■ Green: system is booting</li> <li>■ Blue: application programmable</li> <li>■ Amber Light: front or rear facing camera is in use</li> </ul>

FEATURE	SPECIFICATION
Standard Sensors/ Features	<ul style="list-style-type: none"> <li>■ Ambient light sensor</li> <li>■ Compass</li> <li>■ Accelerometer</li> <li>■ Gyroscope</li> <li>■ TPM (Trusted Platform Module) v2.0</li> </ul>
Temperature Specifications	<ul style="list-style-type: none"> <li>■ Operating Temperature: -4°F to 122°F (-20°C to 50°C). Storage Temperature: -22°F to 158°F (-30°C to 70°C)</li> <li>■ Battery Charging Temperature: 32°F to 122°F (0°C to 50°C)</li> </ul>
Shock Resistance	<ul style="list-style-type: none"> <li>■ Withstands multiple 4 foot drops to concrete</li> </ul>
Environmental Ratings and Standards	<ul style="list-style-type: none"> <li>■ IP68 rating (1.4 meters for 2 hours), waterproof and dustproof</li> <li>■ Designed to MIL-STD810G. Tests: ME-60: sand &amp; dust ME-51,53,&amp; 54: X,Y,&amp; Z-axis helicopter vibrate ME-55, 56, &amp; 57: X, Y, &amp; Z -axis general vibrate ME-52: Water Immersion, 1 meter ME-59: Aggravated Temperature-Humidity cycle ME-67: Temperature cycle ME-62: Temperature shock ME-66: Altitude</li> </ul>
Certifications and Standards	<ul style="list-style-type: none"> <li>■ FCC Class B</li> <li>■ CE Marking</li> <li>■ Industry Canada</li> <li>■ Australia (ACMA)</li> <li>■ <i>Bluetooth</i> SIG qualification</li> <li>■ IP68 waterproof and dustproof</li> <li>■ Designed to MIL-STD 810G</li> <li>■ RoHS 2 compliant</li> <li>■ Mesa 3 is certified on AT&amp;T networks</li> </ul>

FEATURE	SPECIFICATION
Warranties	<ul style="list-style-type: none"> <li>■ 24 months for Mesa 3</li> <li>■ 90 days for accessories</li> <li>■ Extended service and maintenance plans</li> </ul>
Software Included	<ul style="list-style-type: none"> <li>■ Alarms &amp; Clock</li> <li>■ Calculator</li> <li>■ Calendar</li> <li>■ Camera</li> <li>■ Cortana</li> <li>■ Device Info (config/control)</li> <li>■ File Explorer</li> <li>■ Geode Connect</li> <li>■ Groove Music</li> <li>■ Keypad (config/control)</li> <li>■ Magnifier</li> <li>■ Mail</li> <li>■ Maps</li> <li>■ Messaging</li> <li>■ Microsoft Edge</li> <li>■ Narrator</li> <li>■ OneNote</li> <li>■ Photos</li> <li>■ Snipping Tool</li> <li>■ Sticky Notes</li> <li>■ Store</li> <li>■ Task Manager</li> <li>■ Touchscreen Profiles (config/control)</li> <li>■ Voice Recorder</li> <li>■ Windows PowerShell</li> <li>■ Windows Speech Recognition</li> </ul> <p><i>Software on individual units may vary from list based on the model</i></p>

FEATURE	SPECIFICATION
Configurations	<p>All models and features for the Mesa 3 are configured for United States/ Canada, European Union or Australia.</p> <p>Mesa 3 is offered in the following models:</p> <ul style="list-style-type: none"> <li>■ Base Model</li> <li>■ Geo Model - With u-blox NEO-M8N receiver and integrated antenna (optional upgrade: u-blox NEO-M8T receiver with external antenna port)</li> </ul> <p>The following configurations are available for either model:</p> <ul style="list-style-type: none"> <li>■ 128 GB or 256 GB flash storage</li> <li>■ 8 GB RAM</li> <li>■ Wi-Fi</li> <li>■ Long range <i>Bluetooth</i> wireless technology</li> <li>■ Front and rear facing cameras</li> <li>■ 4G LTE cell modem</li> <li>■ Internal battery</li> <li>■ Hot-swappable battery</li> <li>■ Keypad (portrait or landscape)</li> <li>■ Barcode scanner</li> <li>■ RFID readers</li> <li>■ Barcode scanner and RFID reader</li> <li>■ RS-232 port (5V or 12V supply)</li> </ul>
Camera	<ul style="list-style-type: none"> <li>■ Resolution: 8 MP rear, 2 MP front</li> <li>■ Auto focus</li> <li>■ Video capture</li> <li>■ JPEG image format</li> <li>■ Flash</li> </ul>



FEATURE	SPECIFICATION
4G LTE Data Modem	<ul style="list-style-type: none"> <li>■ Sierra Wireless AirPrime EM7455 or EM7430 (region dependant)</li> <li>■ Supports micro-SIM card only. Micro-SIM card header inside battery compartment with card detect feature and card retainer.</li> <li>■ Does not support voice calls or SMS</li> <li>■ Supports 3G UMTS, HSPA, HSPA+, WCDMA, LTE</li> </ul> <p><i>* See more details at the end of this chapter</i></p>
GPS/GNSS	<ul style="list-style-type: none"> <li>■ 2 to 5 meter typical accuracy</li> <li>■ u-blox NEO-M8N GNSS receiver and integrated antenna</li> <li>■ Integrated real-time SBAS receiver (WAAS, EGNOS, etc.)</li> <li>■ 72 GNSS tracking channels</li> <li>■ Optional upgrade: u-blox NEO-M8T with post-processing data output and external GNSS antenna connection for sub-meter accuracy</li> </ul>
UHF RFID	<ul style="list-style-type: none"> <li>■ Optional built-in UHF RFID module and antenna</li> <li>■ Region-specific frequency configurations (859–873 MHz &amp; 915–930 MHz)</li> <li>■ EPCglobal Gen 2 (ISO 18000-6C) protocol support</li> <li>■ Wide output range (0 dBm to +27 dBm)</li> </ul>

FEATURE	SPECIFICATION
Barcode 1D/2D Imager	<ul style="list-style-type: none"> <li>■ Imager and Decoder: Motorola/Symbol SE4710 imager and PL3307C 400 MHz decoder</li> <li>■ Sensor Resolution: 1280 x 800</li> <li>■ Field of View: Horizontal 42°, vertical 28°</li> <li>■ Reading Angles: Skew &amp; pitch ±60°, roll 360°</li> <li>■ Read Range: 1" to 24" depending on code type, size, and density</li> <li>■ Aiming dot: Visible with low light illumination</li> <li>■ Symbologies: All common 1D, 2D (PDF417, MicroPDF417, Composite, RSS, TLC-39, Data matrix, QR code, Micro QR code, Aztec, MaxiCode, Postal codes, etc.)</li> <li>■ Trigger Buttons: Programmable</li> <li>■ Barcode Connector™ Utility: Wedge and configuration</li> <li>■ Power: 1.49 W active, 0.54 W standby, 8 mW sleep; by default device returns to sleep after 1 second of inactivity</li> </ul>
RS-232	<ul style="list-style-type: none"> <li>■ RS-232C 9-pin D-sub connector</li> <li>■ Hardware option for either 5 V @ 600 mA or 12 V @ 390 mA available on pin 9 (ring in)</li> </ul>
Standard Accessories	<ul style="list-style-type: none"> <li>■ Removable Li-Ion battery</li> <li>■ Adjustable hand strap</li> <li>■ AC wall charger with international plug kit <ul style="list-style-type: none"> <li>- Input: 100-240 VAC, 50/60 Hz, 0.8 A</li> <li>- Output: 12 VDC, 2.5 A</li> </ul> </li> <li>■ Capacitive fine tip stylus with tether</li> <li>■ Quick Start Guide</li> <li>■ Owner's Manual (on our website)</li> <li>■ Two year warranty on Mesa 3</li> </ul>

FEATURE	SPECIFICATION
Optional Accessories	<ul style="list-style-type: none"> <li>■ Internal extended battery, 7.2 V @ 3 Ah, 21.6 Wh Li-Ion</li> <li>■ Integrated UHF RFID Reader and Antenna</li> <li>■ Integrated RS-232 9-Pin, D-Sub Communication</li> <li>■ u-blox NEO-M8T GNSS receiver and external antenna connection</li> <li>■ Survey/GPS pole clamp and mount</li> <li>■ Pistol Grip for reading barcodes</li> <li>■ Holster for Pistol Grip and Mesa 3</li> <li>■ Vehicle charger cable, 12 V vehicle power port, 6 ft.</li> <li>■ Vehicle Mounting Dock with 12 VDC power port, vehicle charger, and USB port</li> <li>■ Vehicle Dock/Pole mount - dock attachment</li> <li>■ Office Docking Station with power/charge input, HDMI output, 3 USB 2.0 (full size A), Ethernet</li> <li>■ AC wall charger, 45 W <ul style="list-style-type: none"> <li>- includes cord with U.S. plug</li> <li>- Input: 120-240 VAC, 50/60 Hz</li> <li>- Output: 12 VDC, 3.75 A</li> </ul> </li> <li>■ Travel charger</li> <li>■ Shoulder strap</li> <li>■ Serial cable</li> <li>■ Holster carrying case</li> <li>■ Flip cover fitted case</li> <li>■ 4-point harness</li> <li>■ SD cards in various sizes</li> <li>■ Screen protector (anti-glare, ultra-clear, or polarized)</li> <li>■ Office 365</li> </ul>

**\* 4G LTE Data Modem - Additional Information**

<b>Mode</b>	<b>Model/Region</b>	<b>Frequency Bands</b>
LTE	North America/EU/ROW	B1, B2, B3, B4, B5, B7, B8, B12, B13, B20, B25, B26, B29, B41
"	Australia	B1, B3, B5, B7, B8, B18, B19, B21, B28, B38, B39, B40, B41
UMTS/HSPA+	North America/EU/ROW	B1, B2, B3, B4, B5, B8
"	Australia	B1, B5, B6, B8, B9, B19

Note: ROW = Rest of World, or Non-North America



# Index

# Index

## Symbols

4G Data Modem

    Data Account, Set up With Wireless Provider 22

    SIM Card Installation 22

## A

Accessories

    Optional 65

    Standard 64

AC Wall Charger 5, 51

Anatomy of the Mesa 2 2–3

Audio Features 12

    Audio Jack 12

    Microphone 12

    Speaker 12

## B

Barcode Connector Utility 23

Barcode Imager 23

    Barcode Connector Utility 23

    Pistol Grip 28

        Holster 28

    Sample Barcodes 26–27

Battery Compartment 3, 4

Battery Door 2–3

Battery Pack, Internal 15–16

Battery Pack, Removable 3–5, 15–17

Battery Packs

    Battery Life 15

    Charge 5, 15, 51

    Install 4–5

    Internal 2, 15–16

    Removable 3, 4

    Specifications 59

    Status 15

    Storage 40

    Warnings 50

Bluetooth Wireless Communication 13–14

## C

- Camera 22
  - Specifications 62
- Care and Maintenance
  - Cleaning 41
  - Storage 40
- Cautions 11, 22, 23, 40, 41, 48, 51
- Certifications and Standards 52
  - Canada 53
  - CE Marking, European Union 54
  - Licensing Information 54
  - Radio Frequency Safety 54
  - United States 52
- Cleaning 41
- Compass 13
  - Compass Calibration 13
- Configurations 62
- Connector Ports 3, 12
- Ctrl-Alt-Delete Function 17
  - Task Manager 17

## D

- Data Modem 22
  - Set up a Data Account 22
  - Install the SIM Card 22
- Data Storage 58
- Declaration of Conformity 54
- Display and Touchscreen 8
  - Backlight 8
- Dock. *See* Office Docking Station or Vehicle Dock
- Documentation 4

## E

- Environmental Ratings and Standards 60

## F

- Features
  - Optional 20
  - Standard 8

## **G**

- Geode Connect 21
- Geo Model 20, 22
- GPS/GNSS 20, 63
  - Geode Connect 21
  - u-blox NEO-M8T GNSS Receiver 20

## **H**

- Hand Strap 6

## **K**

- Keypad
  - Backlight Brightness 10
  - Key Functions 9
  - Programmable Keys 9

## **L**

- LED Activity Indicators 10
- Light Sensor 11
- Limitation of Liability 46
- Locked Up 17

## **M**

- Memory 58
- Microphone 12, 59

## **O**

- Office Docking Station 34
- Operating System 58

## **P**

- Physical Features 58
- Pistol Grip 28
  - Holster 28
- Powering Off 16
- Product Warnings 50



## R

- Recycling the Mesa 2 and Batteries 41
- Removable Battery Pack 3–5
- Repair 48
  - System Information 48
- Repairs, Upgrades, and Evaluations 48
- RFID Reader 29
- RS-232C Port 32

## S

- Screen Protector 65
- SD Cards 11
- Sensors
  - Accelerometer 13
  - Compass
    - Calibration 13
  - Gyroscope 13
- Service Plans 47
- Set up Tasks, Initial 4
- SIM Card 3, 23
- Software Included 61
- Speaker 2
- Specifications 58–65
- Storing the Mesa 2 16, 40
- Stylus 3, 6
  - Stylus Storage Slot 2
  - Tether 6
- System Information 48

## T

- Task Manager 17
- Temperature Specifications 60
- Touchscreen 8–10
  - Calibration Tool 9
  - Protecting the Touchscreen 40
  - Settings 8
  - Specifications 59

## U

- u-blox NEO-M8T GNSS Receiver 20

## **V**

Vehicle Dock 37

## **W**

Wall Charger 5, 15, 51

Warnings 50–51

    Battery Warnings 50–51

    Wall Charger Warnings 51

Warranty 44–47

    Exclusions 44

    Limitation of Liability 46

    Remedy 45

    Repairs 46

    Services 47

    Warranty Exclusions 44

Wi-Fi Wireless Communication 14

    Connecting to a Wi-Fi Network 14